

Stack Frame Components

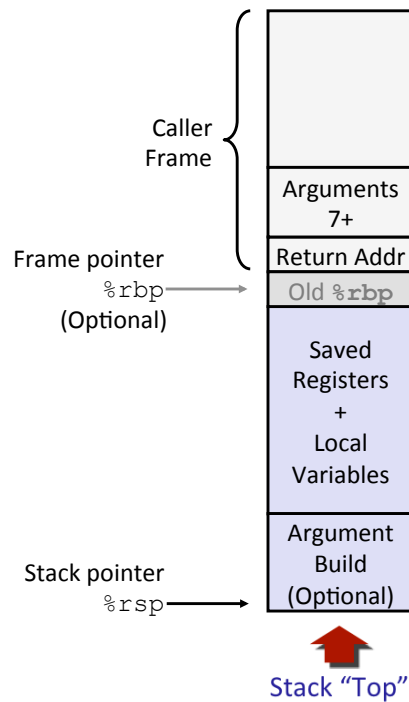

Using the Stack (4)

```
long call_incr() {
    long v1 = 15213;
    long v2 = incr(&v1, 3000);
    return v1+v2;
}
```

```
call_incr:
    subq    $16, %rsp
    movq    $15213, 8(%rsp)
    movl    $3000, %esi
    leaq    8(%rsp), %rdi
    call   incr
    addq    8(%rsp), %rax
    addq    $16, %rsp
    ret
```

Stack Structure

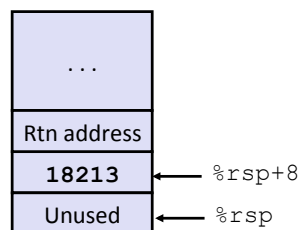

Register	Use(s)
<code>%rax</code>	Return value

Updated Stack Structure

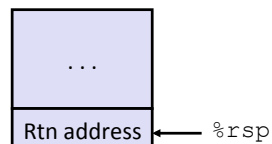

Stack Frame Components

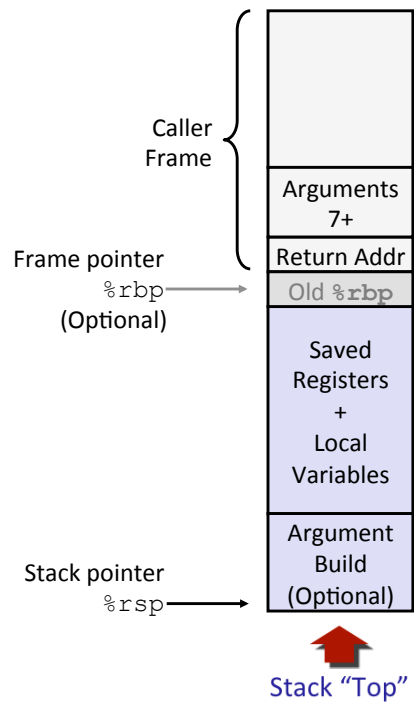

Register Conventions

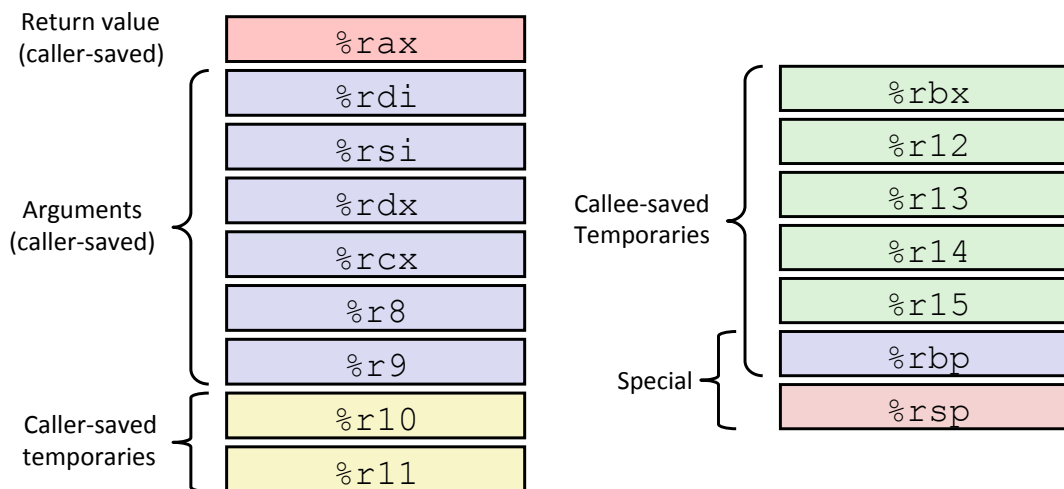

Callee-Saved Example (1)

```
long call_incr2(long x) {  
    long v1 = 15213;  
    long v2 = incr(&v1, 3000);  
    return x+v2;  
}
```

```
call_incr2:  
    pushq    %rbx  
    subq    $16, %rsp  
    movq    %rdi, %rbx  
    movq    $15213, 8(%rsp)  
    movl    $3000, %esi  
    leaq   8(%rsp), %rdi  
    call   incr  
    addq   %rbx, %rax  
    addq   $16, %rsp  
    popq   %rbx  
    ret
```

Initial Stack Structure

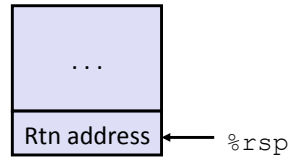

Resulting Stack Structure

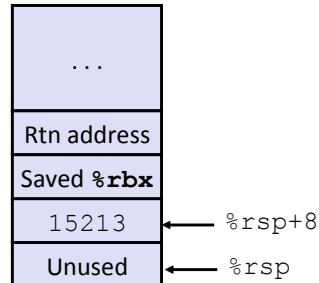

Callee-Saved Example (2)

```
long call_incr2(long x) {  
    long v1 = 15213;  
    long v2 = incr(&v1, 3000);  
    return x+v2;  
}
```

```
call_incr2:  
    pushq    %rbx  
    subq    $16, %rsp  
    movq    %rdi, %rbx  
    movq    $15213, 8(%rsp)  
    movl    $3000, %esi  
    leaq   8(%rsp), %rdi  
    call   incr  
    addq   %rbx, %rax  
    addq   $16, %rsp  
    popq   %rbx  
    ret
```

Resulting Stack Structure

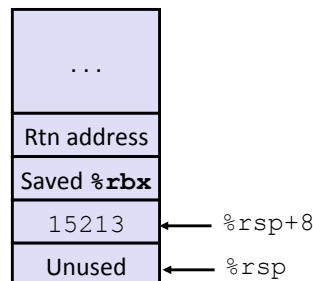

Pre-return Stack Structure

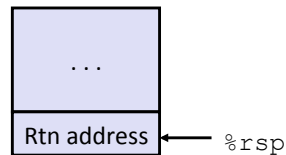

Stack Frame Components

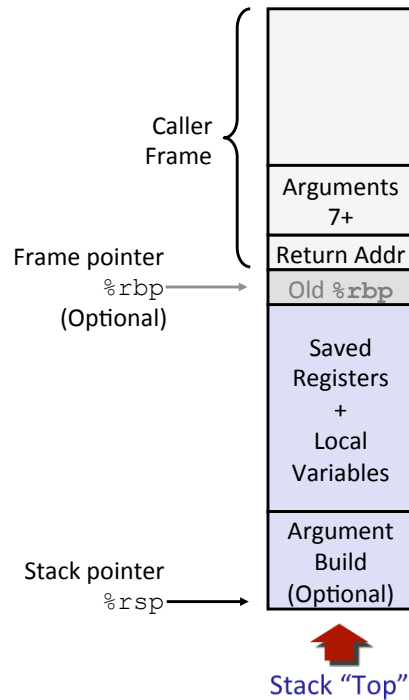

Recursion Example

```
/* Recursive popcount */
long pcount_r(unsigned long x) {
    if (x == 0)
        return 0;
    else
        return (x & 1)
            + pcount_r(x >> 1);
}
```

```
pcount_r:
    movl    $0, %eax
    testq   %rdi, %rdi
    je     .L6
    pushq   %rbx
    movq    %rdi, %rbx
    andl    $1, %ebx
    shrq    %rdi
    call    pcount_r
    addq    %rbx, %rax
    popq    %rbx
.L6:
    rep; ret
```

Recursion Base Case

```

/* Recursive popcount */
long pcount_r(unsigned long x) {
    if (x == 0)
        return 0;
    else
        return (x & 1)
            + pcount_r(x >> 1);
}

```

```

pcount_r:
    movl    $0, %eax
    testq   %rdi, %rdi
    je      .L6
    pushq   %rbx
    movq    %rdi, %rbx
    andl    $1, %ebx
    shrq    %rdi
    call    pcount_r
    addq    %rbx, %rax
    popq    %rbx
.L6:
    rep; ret

```

Register	Use(s)	Type
%rdi	x	Argument
%rax	Return value	Return value

Recursion Register Save

```

/* Recursive popcount */
long pcount_r(unsigned long x) {
    if (x == 0)
        return 0;
    else
        return (x & 1)
            + pcount_r(x >> 1);
}

```

```

pcount_r:
    movl    $0, %eax
    testq   %rdi, %rdi
    je      .L6
    pushq   %rbx
    movq    %rdi, %rbx
    andl    $1, %ebx
    shrq    %rdi
    call    pcount_r
    addq    %rbx, %rax
    popq    %rbx
.L6:
    rep; ret

```

Register	Use(s)	Type
%rdi	x	Argument

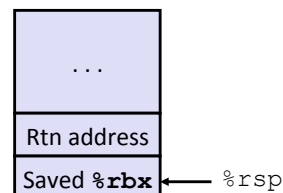

Recursion Call Setup

```
/* Recursive popcount */
long pcount_r(unsigned long x) {
    if (x == 0)
        return 0;
    else
        return (x & 1)
            + pcount_r(x >> 1);
}
```

```
pcount_r:
    movl    $0, %eax
    testq   %rdi, %rdi
    je      .L6
    pushq   %rbx
    movq    %rdi, %rbx
    andl    $1, %ebx
    shrq    %rdi
    call    pcount_r
    addq    %rbx, %rax
    popq    %rbx
.L6:
    rep; ret
```

Register	Use(s)	Type
%rdi	x >> 1	Rec. argument
%rbx	x & 1	Callee-saved

Recursive Call

```
/* Recursive popcount */
long pcount_r(unsigned long x) {
    if (x == 0)
        return 0;
    else
        return (x & 1)
            + pcount_r(x >> 1);
}
```

```
pcount_r:
    movl    $0, %eax
    testq   %rdi, %rdi
    je      .L6
    pushq   %rbx
    movq    %rdi, %rbx
    andl    $1, %ebx
    shrq    %rdi
    call    pcount_r
    addq    %rbx, %rax
    popq    %rbx
.L6:
    rep; ret
```

Register	Use(s)	Type
%rbx	x & 1	Callee-saved
%rax	Recursive call return value	

Recursion Result

```

/* Recursive popcount */
long pcount_r(unsigned long x) {
    if (x == 0)
        return 0;
    else
        return (x & 1)
            + pcount_r(x >> 1);
}

```

```

pcount_r:
    movl    $0, %eax
    testq   %rdi, %rdi
    je      .L6
    pushq   %rbx
    movq    %rdi, %rbx
    andl    $1, %ebx
    shrq    %rdi
    call    pcount_r
    addq    %rbx, %rax
    popq    %rbx
.L6:
    rep; ret

```

Register	Use(s)	Type
%rbx	x & 1	Callee-saved
%rax	Return value	

Recursion Result

```

/* Recursive popcount */
long pcount_r(unsigned long x) {
    if (x == 0)
        return 0;
    else
        return (x & 1)
            + pcount_r(x >> 1);
}

```

```

pcount_r:
    movl    $0, %eax
    testq   %rdi, %rdi
    je      .L6
    pushq   %rbx
    movq    %rdi, %rbx
    andl    $1, %ebx
    shrq    %rdi
    call    pcount_r
    addq    %rbx, %rax
    popq    %rbx
.L6:
    rep; ret

```

Register	Use(s)	Type
%rax	Return value	Return value

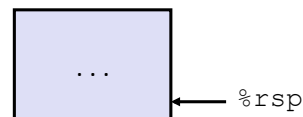

Array Allocation

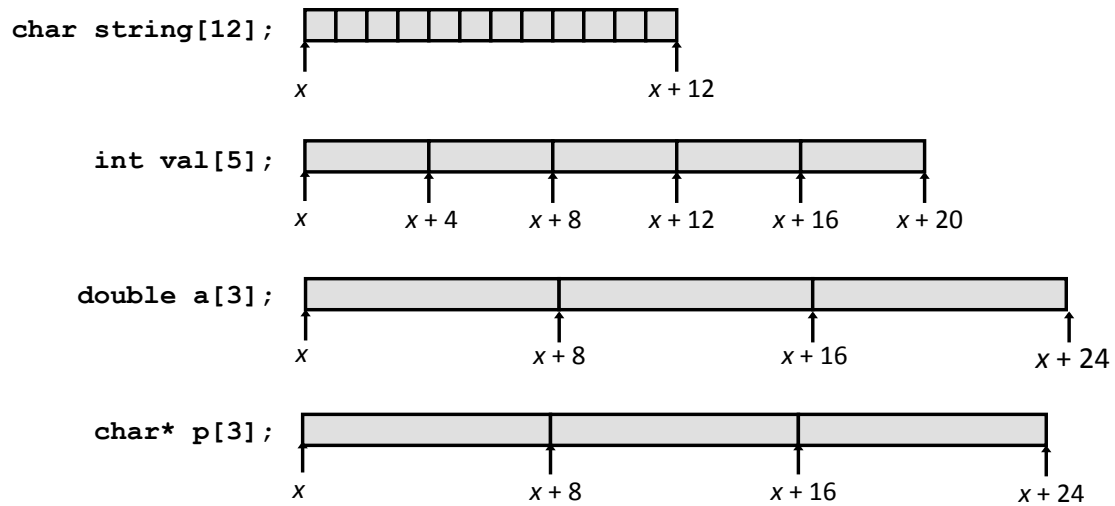

Array Access

```
int get_val(int a[], int i) {  
    return a[i];  
}
```

```
# %rdi = a  
# %rsi = i  
movl (%rdi,%rsi,4), %eax # a[i]
```



Array Looping

```
void inc5(int a[]) {  
    size_t i;  
    for (i = 0; i < 5; i++)  
        a[i]++;  
}
```

```
# %rdi = a  
movl    $0, %eax          # i = 0  
jmp     .L3              # goto middle  
.L4:                          # loop:  
addl    $1, (%rdi,%rax,4) # a[i]++  
addq    $1, %rax         # i++  
.L3:                          # middle  
cmpq    $4, %rax        # i:4  
jbe     .L4              # if <=, goto loop  
rep; ret
```

Multi-Level Array

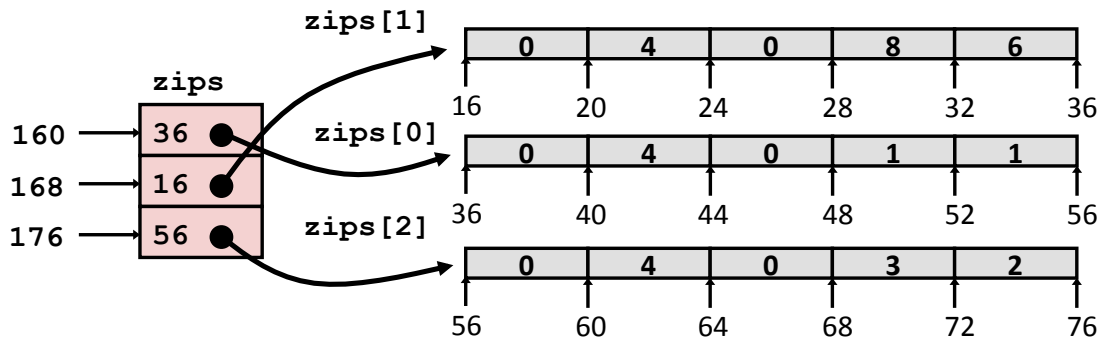
```
int* zips[3];  
zips[0] = (int*) malloc(sizeof(int)*5);  
...
```



Multi-Level Array Example

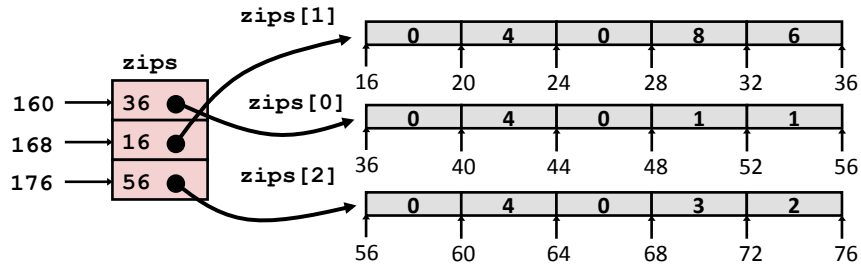

```
int get_zip_digit
(size_t index, size_t digit)
{
    return zips[index][digit];
}
```

```
salq    $2, %rsi          # 4*digit
addq    160(,%rdi,8), %rsi # p = zips[index] + 4*digit
movl    (%rsi), %eax      # return *p
ret
```

Nested Array

```
int A[R][C];
```

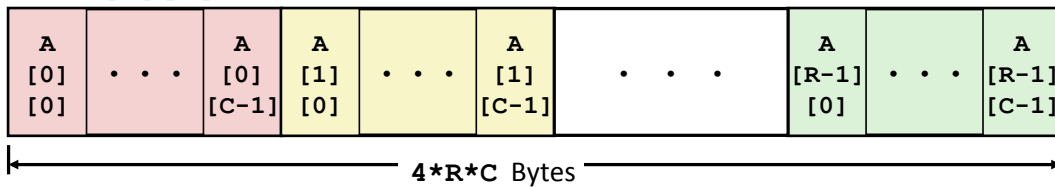

Nested Array Example

```
int zips[4][5];
```

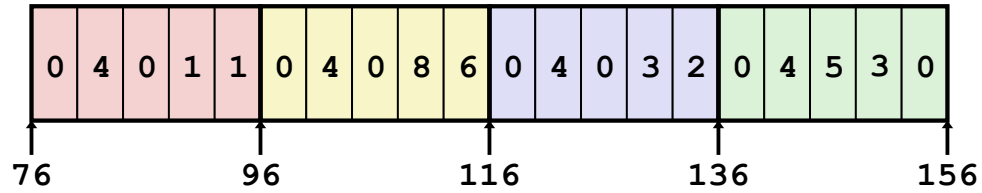

```
int* get_zip(int index)
{
    return zips[index];
}
```

```
# %rdi = index
leaq (%rdi,%rdi,4),%rax # 5 * index
leaq 76(,%rax,4),%rax   # zips + (20 * index)
```