

Machine Code: Procedures

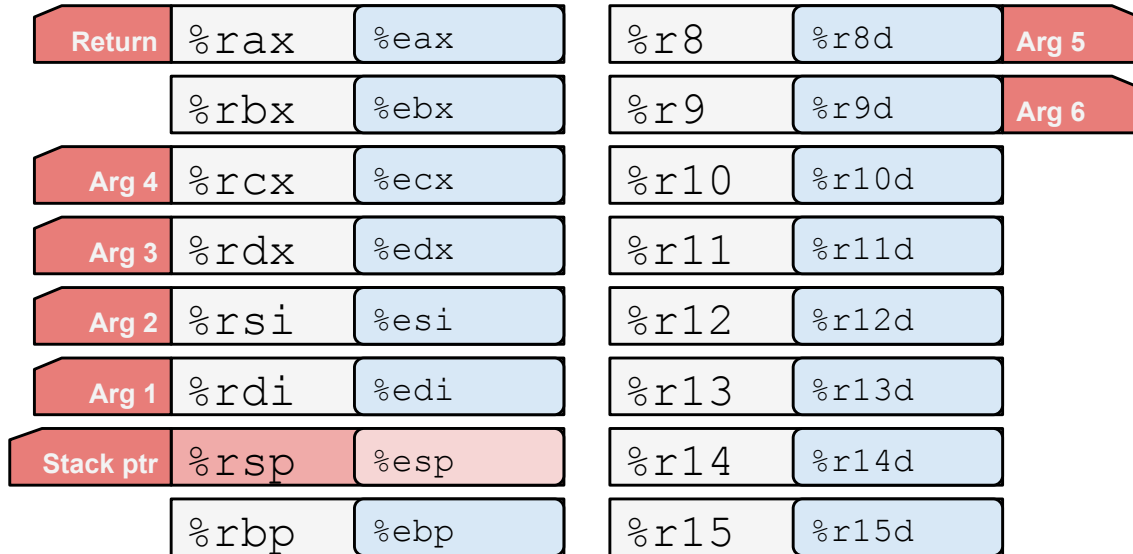

Call Stack

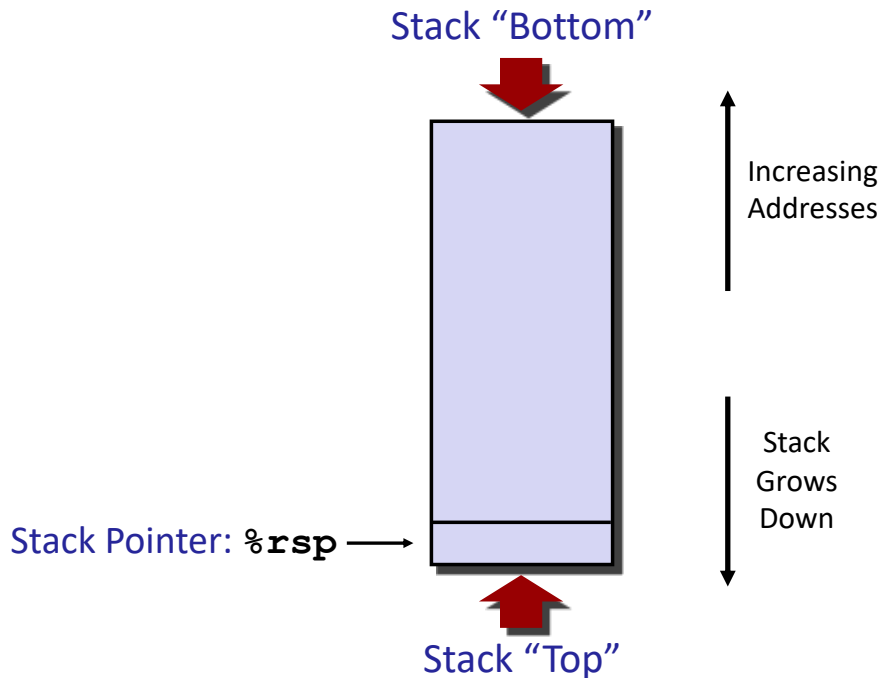

Stack Operations

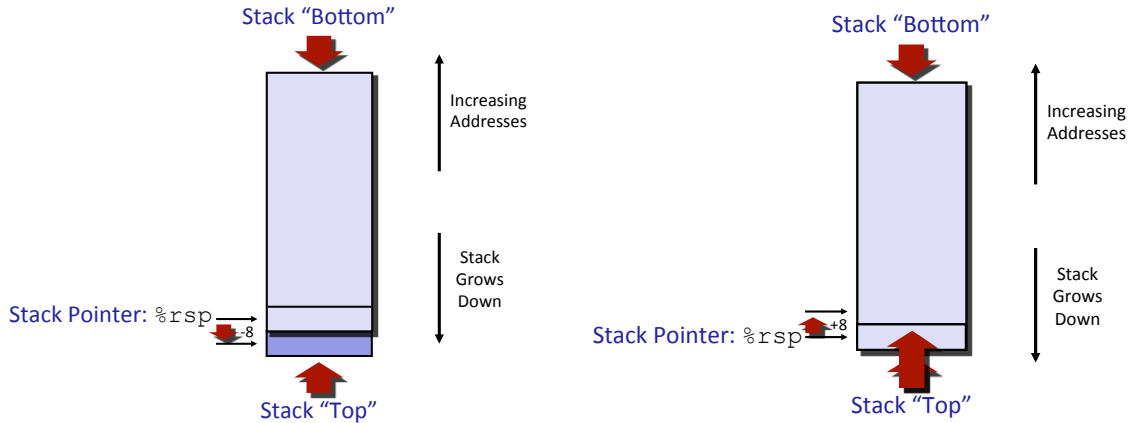

pushq Src

1. Decrement `%rsp` by 8
2. Write `Src` to (`%rsp`)

popq Dest

1. Read (`%rsp`) to `Dest`
2. Increment `%rsp` by 8

Procedure Call Example

```
long x = add(3, 5);  
doSomething(x);
```

```
long add(long x, long y) {  
    return x + y;  
}
```

```
movq $3, %rdi  
movq $5, %rsi  
callq add  
movq %rax, %rdi  
callq doSomething
```

```
add:  
    movq %rdi, %rax  
    addq %rsi, %rax  
    ret
```

Procedure Call Return Addresses (1)

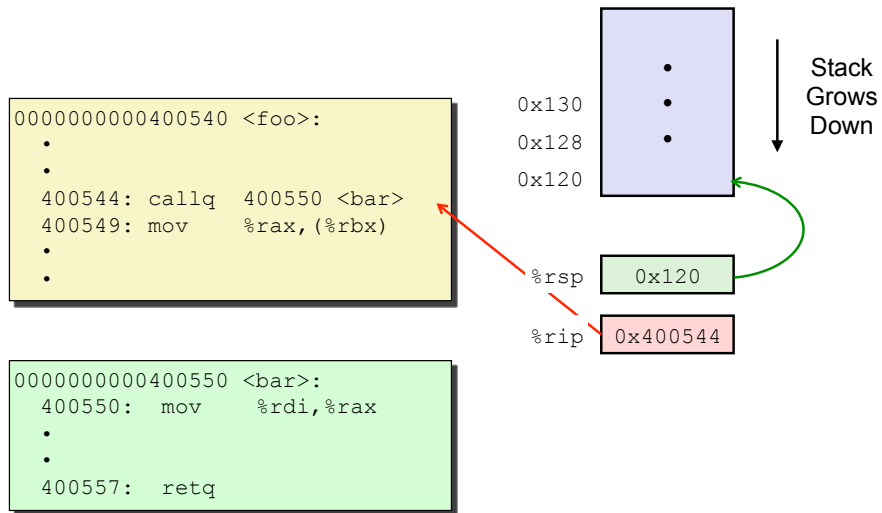

Procedure Call Return Addresses (2)

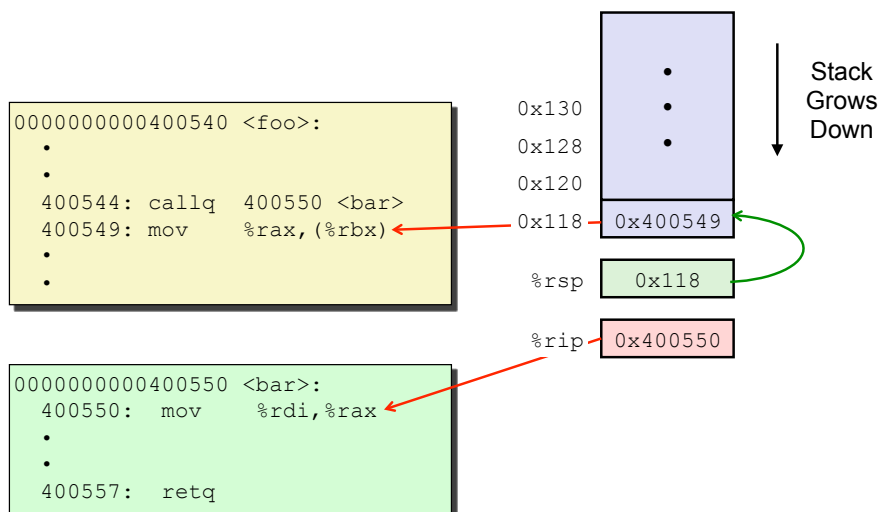

Procedure Call Return Addresses (3)

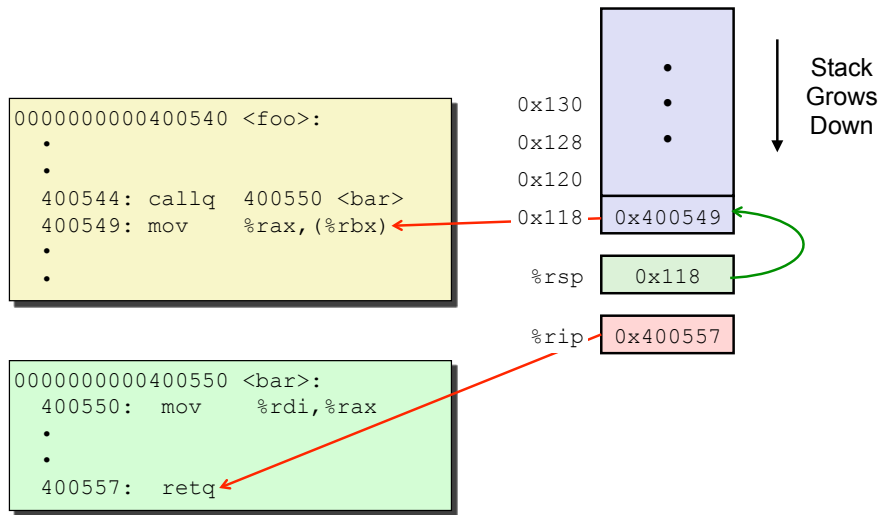

Procedure Call Return Addresses (4)

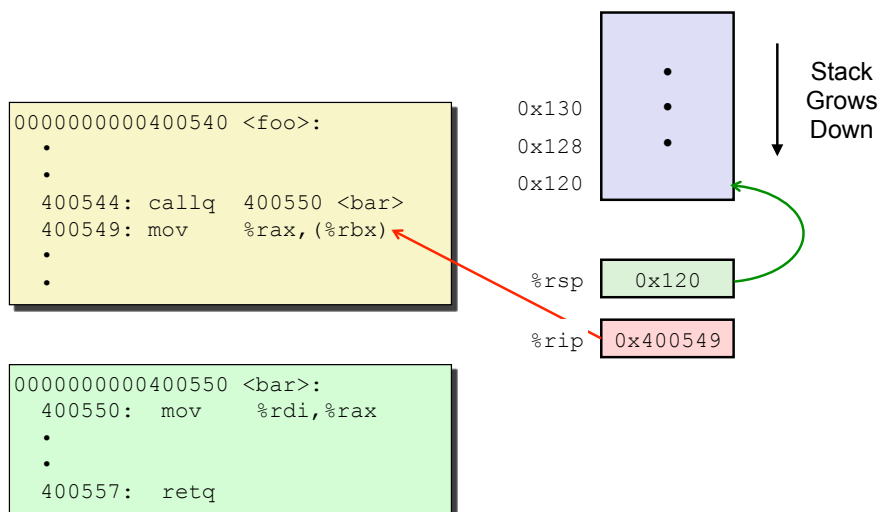

Passing Data

Registers

■ First 6 arguments

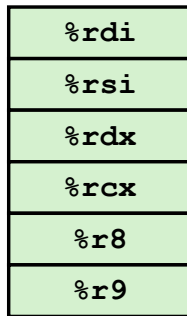

■ Return value

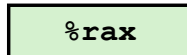

Stack

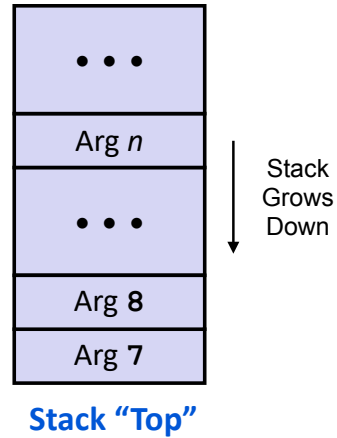

Stack Frames

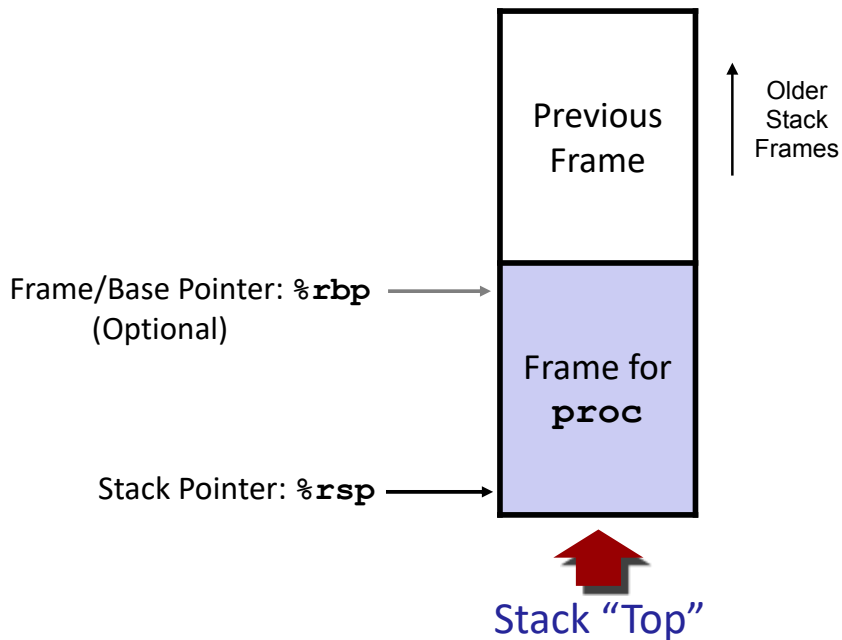

Call Chain Example

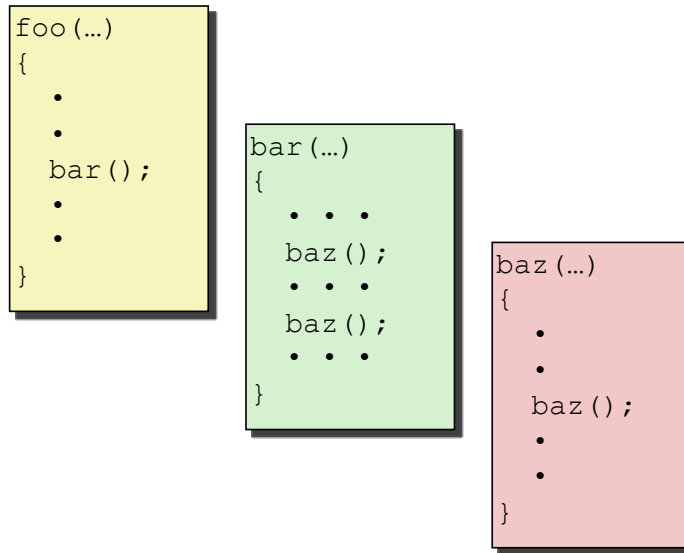

Procedure **baz ()** is recursive

Stack Frame Allocation (1)

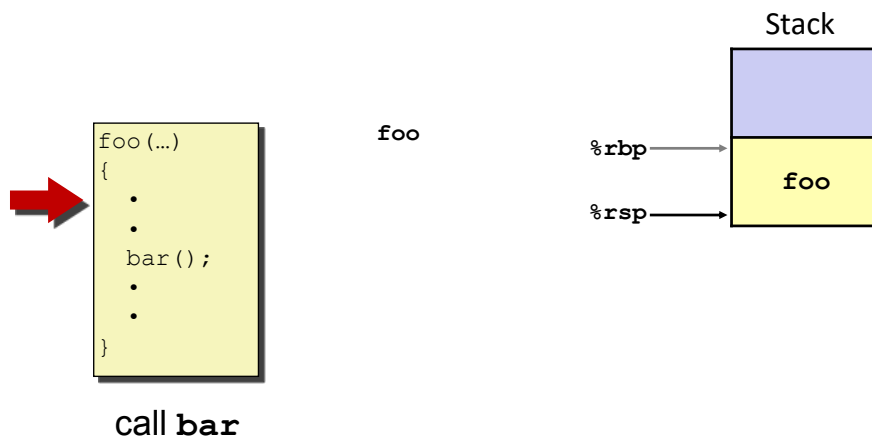

Stack Frame Allocation (2)

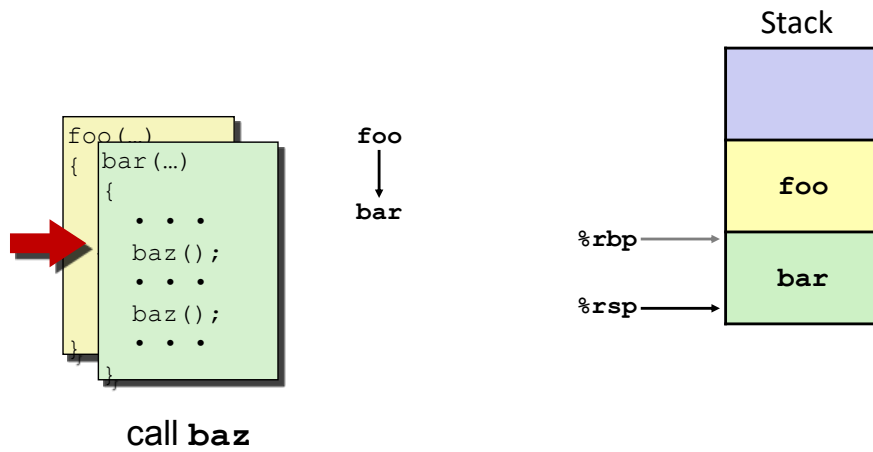

Stack Frame Allocation (3)

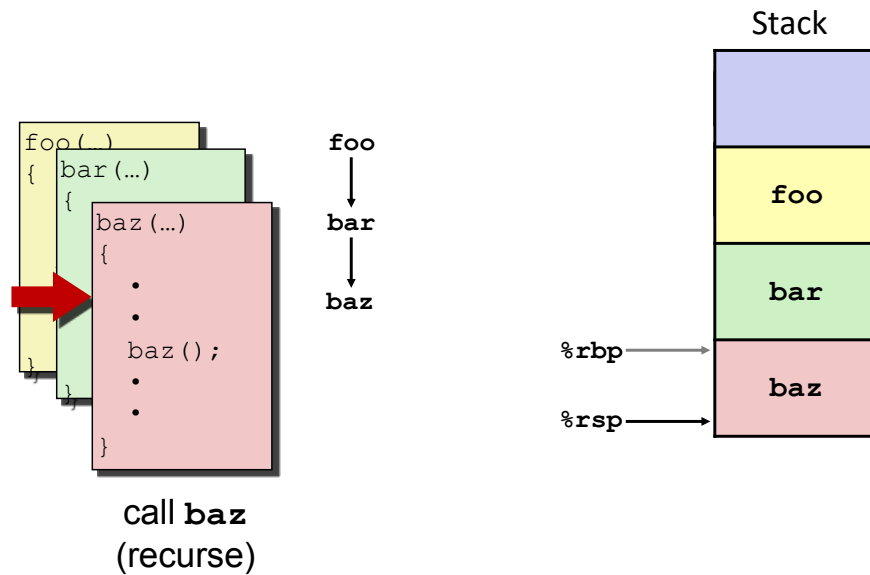

Stack Frame Allocation (4)

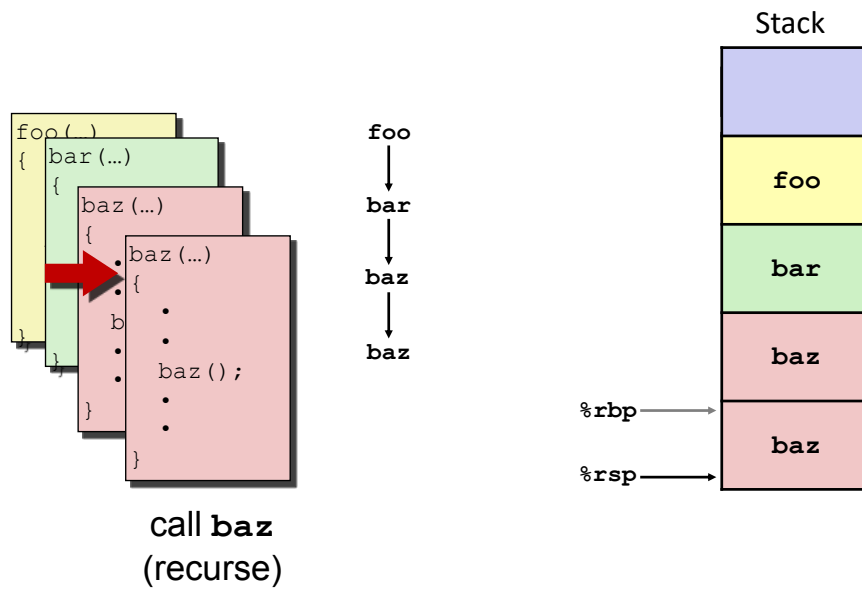

Stack Frame Allocation (5)

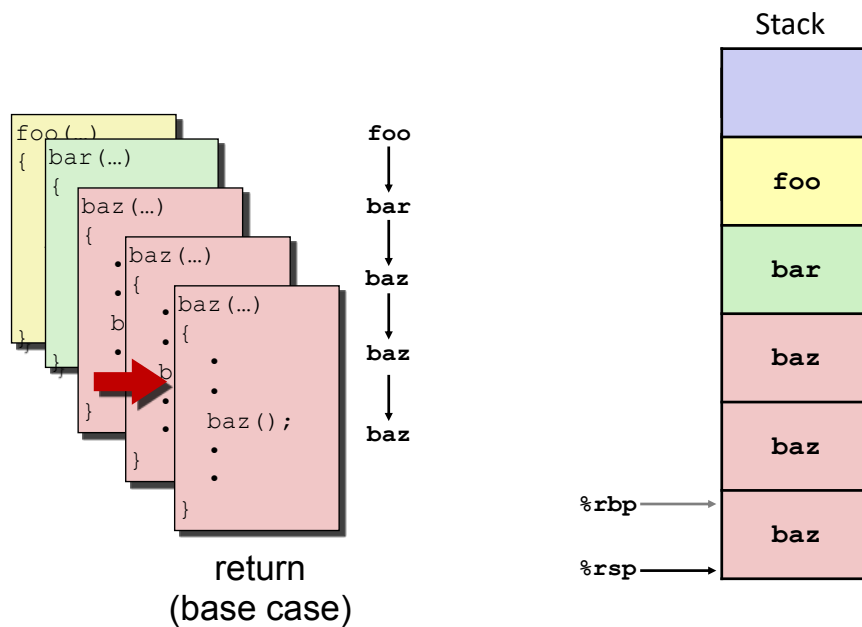

Stack Frame Allocation (6)

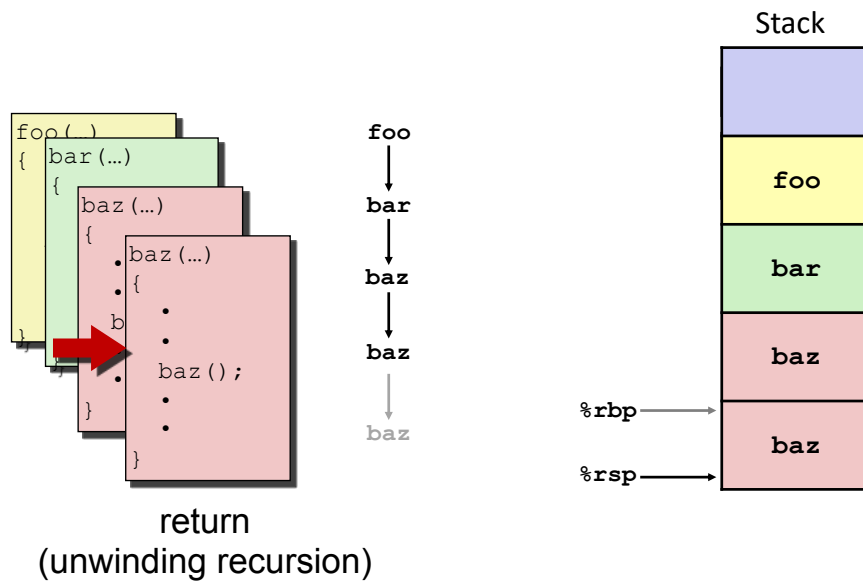

Stack Frame Allocation (7)

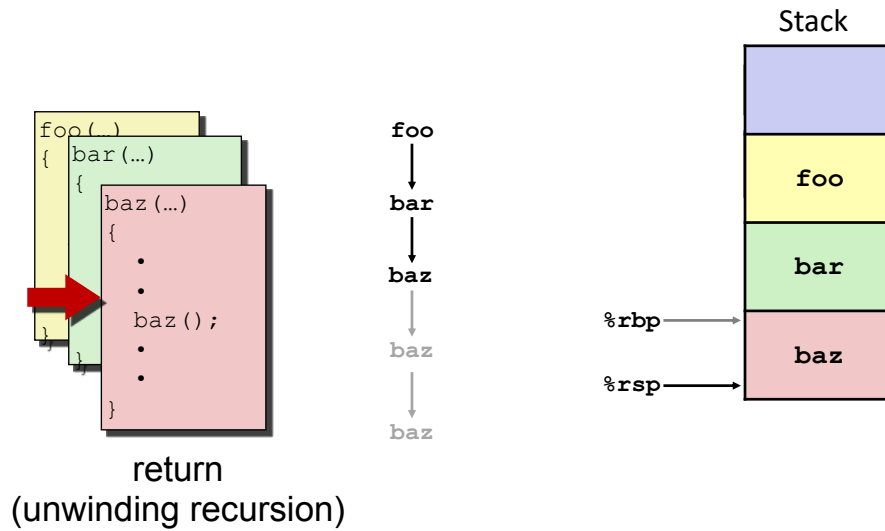

Stack Frame Allocation (8)

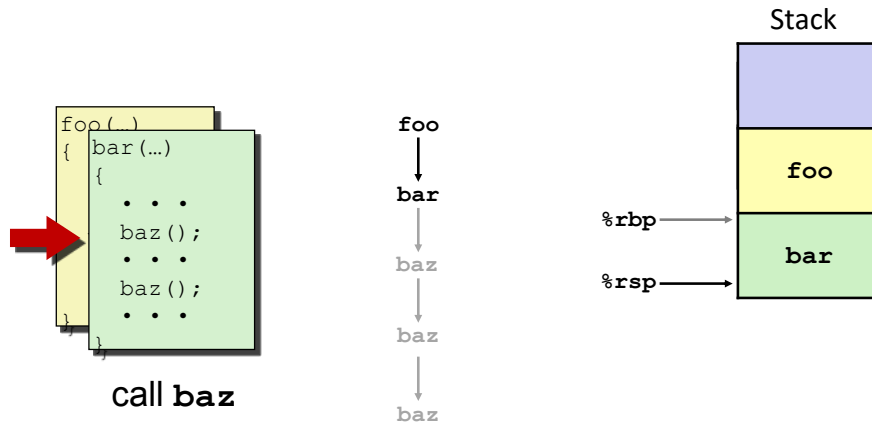

Stack Frame Allocation (9)

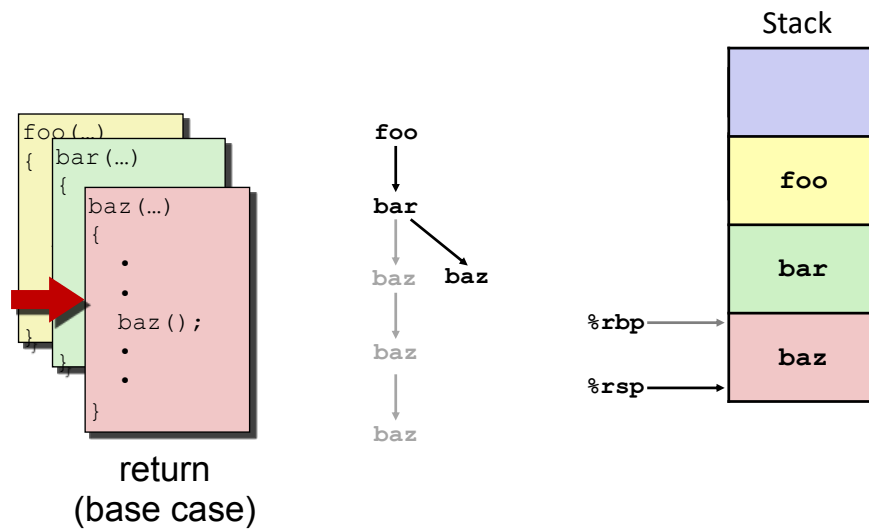

Stack Frame Allocation (10)

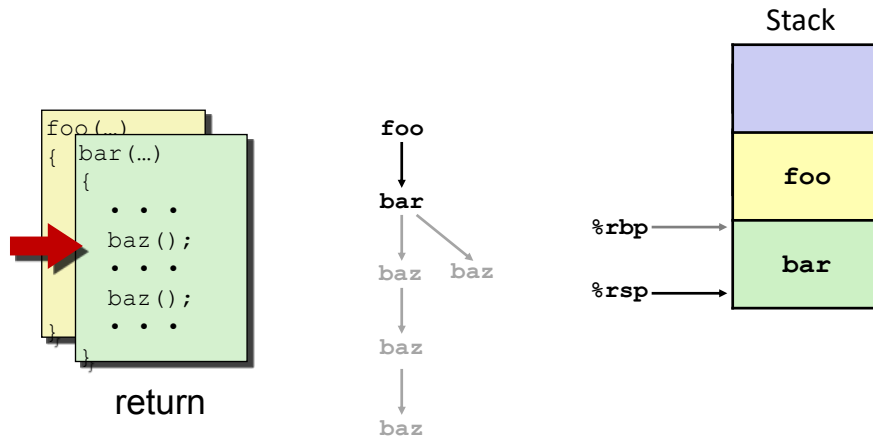

Stack Frame Allocation (11)

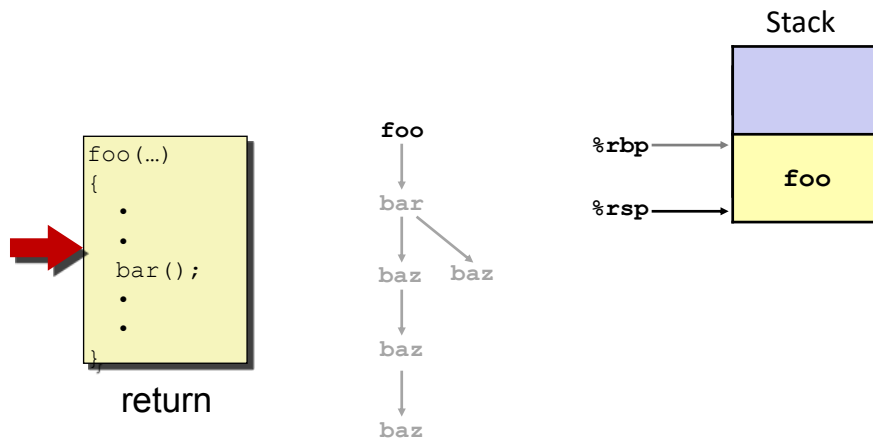

Caller vs. Callee (1)

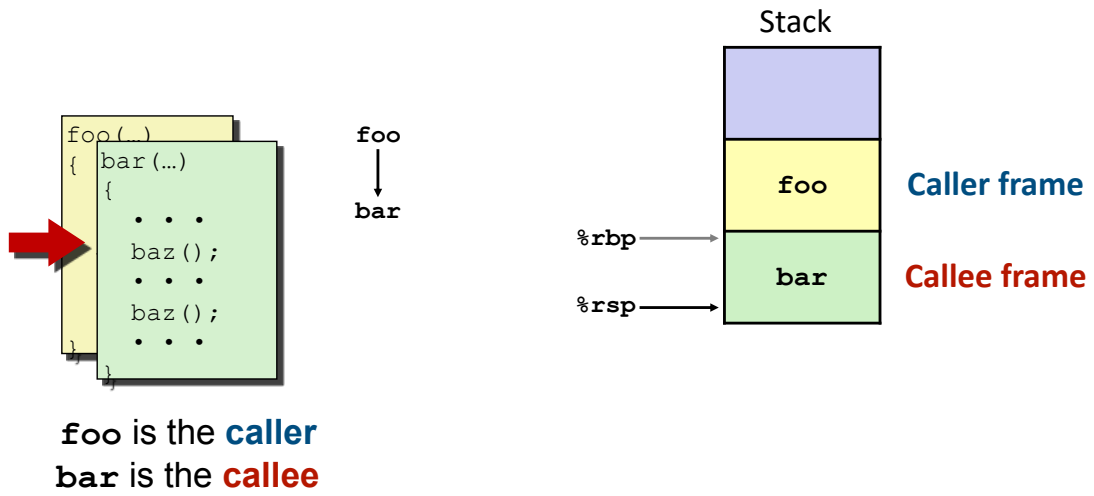

Caller vs. Callee (2)

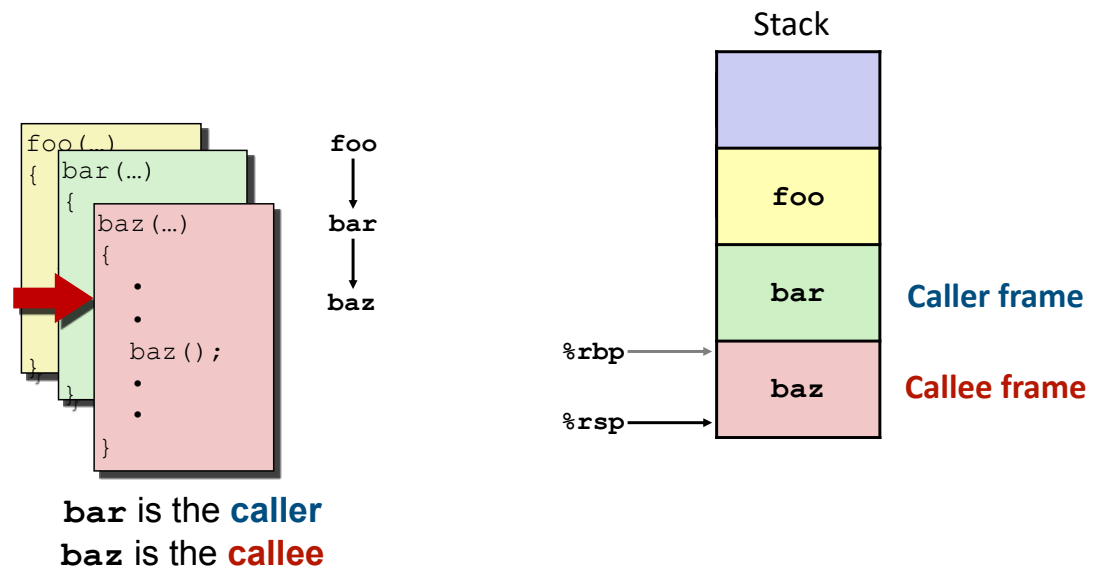

Stack Frame Components

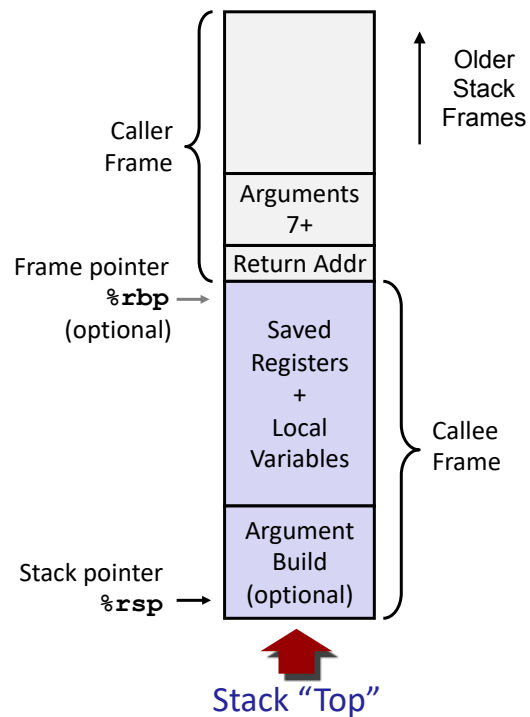

Using the Stack (1)

```
long incr(long* p, long val) {  
    long x = *p;  
    long y = x + val;  
    *p = y;  
    return x;  
}
```

```
incr:  
    movq    (%rdi), %rax  
    addq   %rax, %rsi  
    movq   %rsi, (%rdi)  
    ret
```

Register	Use(s)
%rdi	Argument p
%rsi	Argument val, y
%rax	x, Return value

Using the Stack (2)

```
long foo() {  
    long v1 = 15213;  
    long v2 = incr(&v1, 3000);  
    return v1+v2;  
}
```

Initial Stack Structure

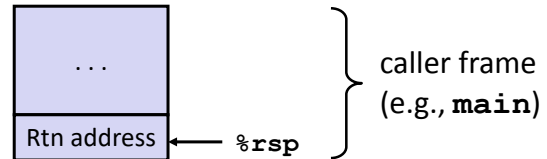

```
foo:  
    subq    $16, %rsp  
    movq    $15213, 8(%rsp)  
    movl    $3000, %esi  
    leaq   8(%rsp), %rdi  
    call   incr  
    addq   8(%rsp), %rax  
    addq   $16, %rsp  
    ret
```

Resulting Stack Structure

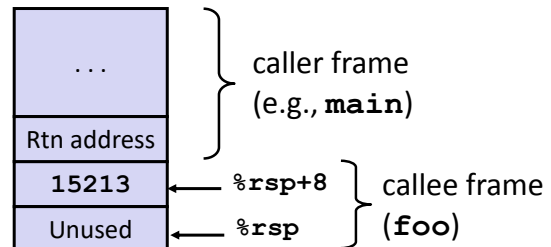

Using the Stack (3)

```
long foo() {  
    long v1 = 15213;  
    long v2 = incr(&v1, 3000);  
    return v1+v2;  
}
```

```
foo:  
    subq    $16, %rsp  
    movq    $15213, 8(%rsp)  
    movl    $3000, %esi  
    leaq   8(%rsp), %rdi  
    call   incr  
    addq   8(%rsp), %rax  
    addq   $16, %rsp  
    ret
```

Stack Structure

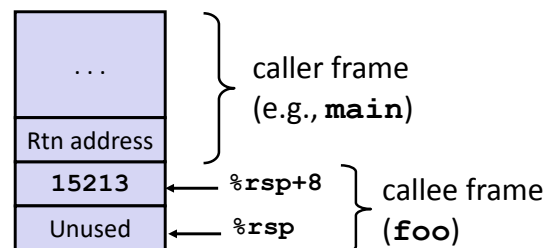

Register	Use(s)
%rdi	&v1
%rsi	3000

Using the Stack (4)

```
long foo() {
    long v1 = 15213;
    long v2 = incr(&v1, 3000);
    return v1+v2;
}
```

```
foo:
    subq    $16, %rsp
    movq    $15213, 8(%rsp)
    movl    $3000, %esi
    leaq    8(%rsp), %rdi
    call   incr
    addq    8(%rsp), %rax
    addq    $16, %rsp
    ret
```

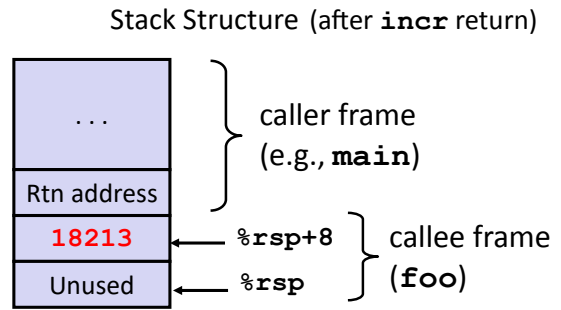

Register	Use(s)
<code>%rdi</code>	<code>&v1</code>
<code>%rsi</code>	3000

```
incr:
    movq    (%rdi), %rax
    addq    %rax, %rsi
    movq    %rsi, (%rdi)
    ret
```

Using the Stack (5)

```
long foo() {
    long v1 = 15213;
    long v2 = incr(&v1, 3000);
    return v1+v2;
}
```

```
foo:
    subq    $16, %rsp
    movq    $15213, 8(%rsp)
    movl    $3000, %esi
    leaq    8(%rsp), %rdi
    call   incr
    addq    8(%rsp), %rax
    addq    $16, %rsp
    ret
```

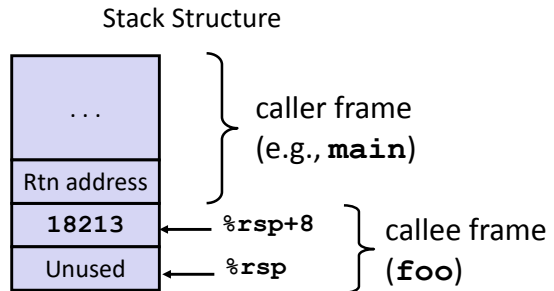

Register	Use(s)
<code>%rax</code>	Return value

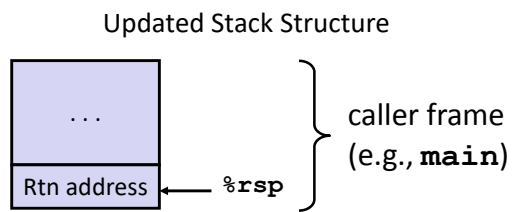

Using the Stack (6)

```
long foo() {
    long v1 = 15213;
    long v2 = incr(&v1, 3000);
    return v1+v2;
}
```

Updated Stack Structure

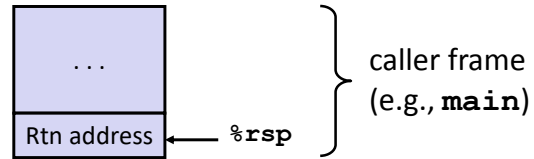

```
foo:
    subq    $16, %rsp
    movq    $15213, 8(%rsp)
    movl    $3000, %esi
    leaq    8(%rsp), %rdi
    call    incr
    addq    8(%rsp), %rax
    addq    $16, %rsp
    ret
```

Register	Use(s)
%rax	Return value

Final Stack Structure

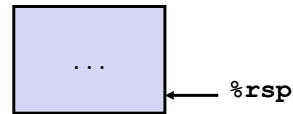

Stack Frame Components

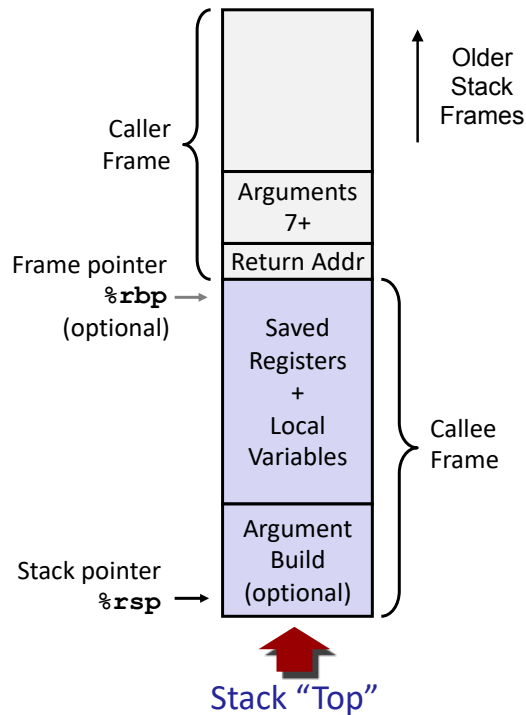

Register Conventions

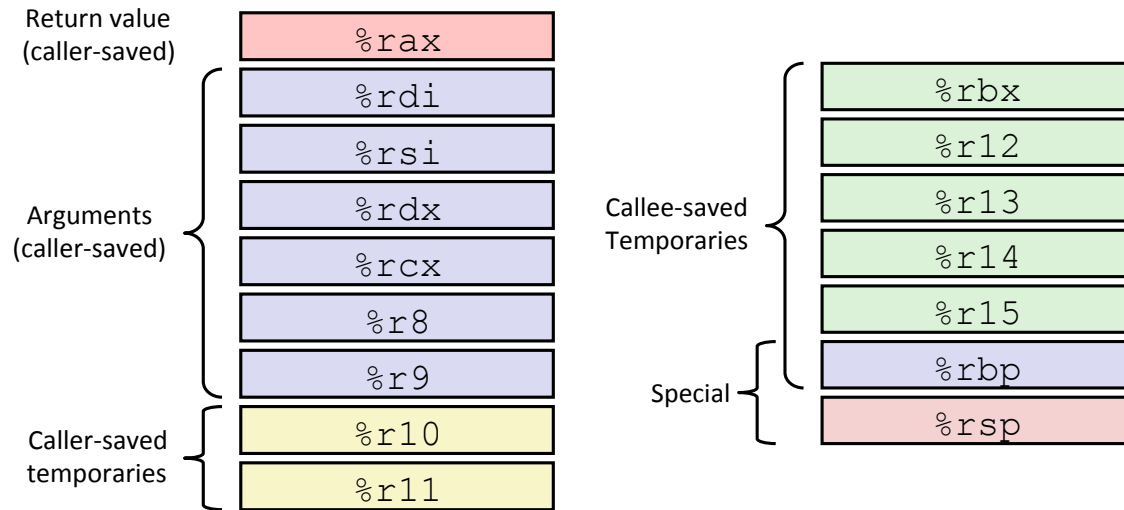

Caller-Saved vs. Callee-Saved (1)

```
alice:
  movq X, %reg    # compute X
  callq bob
  movq %reg, ... # use X
```

← Could overwrite %reg!

Caller-Saved %reg

```
alice:
  movq X, %reg # compute X
  pushq %reg  # save X
  callq bob   # might change X
  popq %reg   # restore X
  movq %reg, ... # use X
```

Callee-Saved %reg

```
alice:
  pushq %reg # save caller's
  movq X, %reg # compute X
  callq bob # preserves X
  movq %reg, ... # use X
  popq %reg # restore caller
```

Caller-Saved vs. Callee-Saved (2)

```
alice:
    movq X, %reg    # compute X
    callq bob
    ...            # don't need X again
```

Caller-Saved %reg

```
alice:
    movq X, %reg    # compute X
    callq bob      # might change X
    ...
```



Avoids save/restore!

Callee-Saved %reg

```
alice:
    pushq %reg     # save caller's
    movq X, %reg   # compute X
    callq bob      # preserves X
    ...
    popq %reg      # restore caller
```

Caller-Saved vs. Callee-Saved (3)

```
alice:
    movq X, %reg    # compute X
    callq bob
    movq %reg, ... # use X
    callq charlie
    movq %reg, ... # use X
```

Callee-Saved %reg

```
alice:
    pushq %reg     # save caller's
    movq X, %reg   # compute
    callq bob      # preserves X
    movq %reg, ... # use X
    callq charlie  # preserves X
    movq %reg, ... # use X
    popq %reg      # restore caller
```

Caller-Saved %reg

```
alice:
    movq X, %reg   # compute X
    pushq %reg     # save X
    callq bob      # might change X
    popq %reg      # restore X
    movq %reg, ... # use X
    pushq %reg     # save X
    callq charlie  # might change
    popq %reg      # restore X
    movq %reg, ... # use X
```

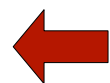

Only one save/restore!

Callee-Saved Example (1)

```
long foo2(long x) {  
    long v1 = 15213;  
    long v2 = incr(&v1, 3000);  
    return x+v2;  
}
```

```
foo2:  
    pushq    %rbx  
    subq    $16, %rsp  
    movq    %rdi, %rbx  
    movq    $15213, 8(%rsp)  
    movl    $3000, %esi  
    leaq    8(%rsp), %rdi  
    call    incr  
    addq    %rbx, %rax  
    addq    $16, %rsp  
    popq    %rbx  
    ret
```

Initial Stack Structure

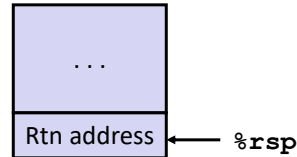

Resulting Stack Structure

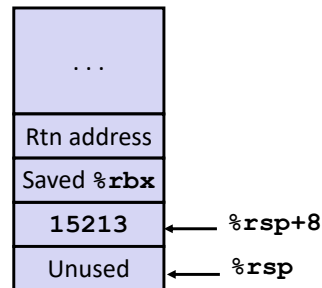

Callee-Saved Example (2)

```
long foo2(long x) {  
    long v1 = 15213;  
    long v2 = incr(&v1, 3000);  
    return x+v2;  
}
```

```
foo2:  
    pushq    %rbx  
    subq    $16, %rsp  
    movq    %rdi, %rbx  
    movq    $15213, 8(%rsp)  
    movl    $3000, %esi  
    leaq    8(%rsp), %rdi  
    call    incr  
    addq    %rbx, %rax  
    addq    $16, %rsp  
    popq    %rbx  
    ret
```

Resulting Stack Structure

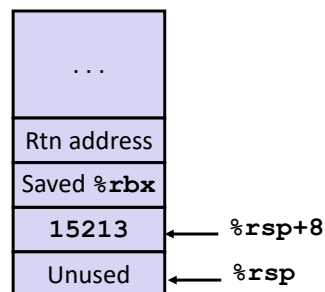

Pre-return Stack Structure

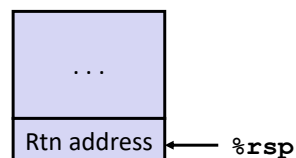

Recursive Example

```
/* recursive bitcount */
long bitcount_r(unsigned long x) {
    if (x == 0) {
        return 0;
    } else {
        long bit = x & 1;
        long rest = bitcount_r(x >> 1);
        return bit + rest;
    }
}
```

```
bitcount_r:
    movl    $0, %eax
    testq   %rdi, %rdi
    je      .L6
    pushq   %rbx
    movq    %rdi, %rbx
    andl    $1, %ebx
    shrq    %rdi
    call    bitcount_r
    addq    %rbx, %rax
    popq    %rbx
.L6:
    ret
```

Recursive Base Case

```
/* recursive bitcount */
long bitcount_r(unsigned long x) {
    if (x == 0) {
        return 0;
    } else {
        long bit = x & 1;
        long rest = bitcount_r(x >> 1);
        return bit + rest;
    }
}
```

```
bitcount_r:
    movl    $0, %eax
    testq   %rdi, %rdi
    je      .L6
    pushq   %rbx
    movq    %rdi, %rbx
    andl    $1, %ebx
    shrq    %rdi
    call    bitcount_r
    addq    %rbx, %rax
    popq    %rbx
.L6:
    ret
```

Register	Use(s)	Type
%rdi	x	Argument
%rax	Return value	Return value

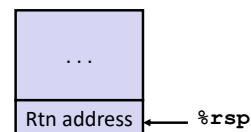

Recursive Register Save

```

/* recursive bitcount */
long bitcount_r(unsigned long x) {
    if (x == 0) {
        return 0;
    } else {
        long bit = x & 1;
        long rest = bitcount_r(x >> 1);
        return bit + rest;
    }
}

```

```

bitcount_r:
    movl    $0, %eax
    testq   %rdi, %rdi
    je      .L6
    pushq   %rbx
    movq    %rdi, %rbx
    andl    $1, %ebx
    shrq    %rdi
    call    bitcount_r
    addq    %rbx, %rax
    popq    %rbx
.L6:
    ret

```

Register	Use(s)	Type
%rbx	Caller's value	Callee-saved

Caller's value! →

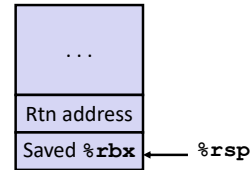

Recursive Call Setup

```

/* recursive bitcount */
long bitcount_r(unsigned long x) {
    if (x == 0) {
        return 0;
    } else {
        long bit = x & 1;
        long rest = bitcount_r(x >> 1);
        return bit + rest;
    }
}

```

```

bitcount_r:
    movl    $0, %eax
    testq   %rdi, %rdi
    je      .L6
    pushq   %rbx
    movq    %rdi, %rbx
    andl    $1, %ebx
    shrq    %rdi
    call    bitcount_r
    addq    %rbx, %rax
    popq    %rbx
.L6:
    ret

```

Register	Use(s)	Type
%rbx	x & 1	Callee-saved
%rdi	x >> 1	Recursive arg

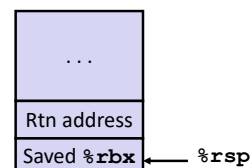

Recursive Call

```

/* recursive bitcount */
long bitcount_r(unsigned long x) {
    if (x == 0) {
        return 0;
    } else {
        long bit = x & 1;
        long rest = bitcount_r(x >> 1);
        return bit + rest;
    }
}

```

```

bitcount_r:
    movl    $0, %eax
    testq  %rdi, %rdi
    je     .L6
    pushq  %rbx
    movq   %rdi, %rbx
    andl   $1, %ebx
    shrq   %rdi
    call   bitcount_r
    addq   %rbx, %rax
    popq   %rbx
.L6:
    ret

```

Register	Use(s)	Type
%rbx	x & 1	Callee-saved
%rax	Subcall result	Return value

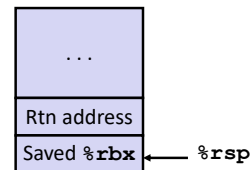

Recursive Result

```

/* recursive bitcount */
long bitcount_r(unsigned long x) {
    if (x == 0) {
        return 0;
    } else {
        long bit = x & 1;
        long rest = bitcount_r(x >> 1);
        return bit + rest;
    }
}

```

```

bitcount_r:
    movl    $0, %eax
    testq  %rdi, %rdi
    je     .L6
    pushq  %rbx
    movq   %rdi, %rbx
    andl   $1, %ebx
    shrq   %rdi
    call   bitcount_r
    addq   %rbx, %rax
    popq   %rbx
.L6:
    ret

```

Register	Use(s)	Type
%rbx	x & 1	Callee-saved
%rax	Combined result	Return value

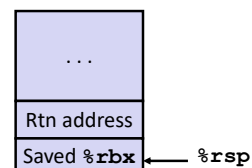

Recursive Completion

```

/* recursive bitcount */
long bitcount_r(unsigned long x) {
    if (x == 0) {
        return 0;
    } else {
        long bit = x & 1;
        long rest = bitcount_r(x >> 1);
        return bit + rest;
    }
}

```

```

bitcount_r:
    movl    $0, %eax
    testq   %rdi, %rdi
    je      .L6
    pushq   %rbx
    movq    %rdi, %rbx
    andl    $1, %ebx
    shrq    %rdi
    call    bitcount_r
    addq    %rbx, %rax
    popq    %rbx
.L6:
    ret

```

Register	Use(s)	Type
%rax	Combined result	Return value

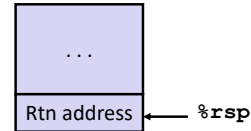

Stack Frame Components

