

Paging

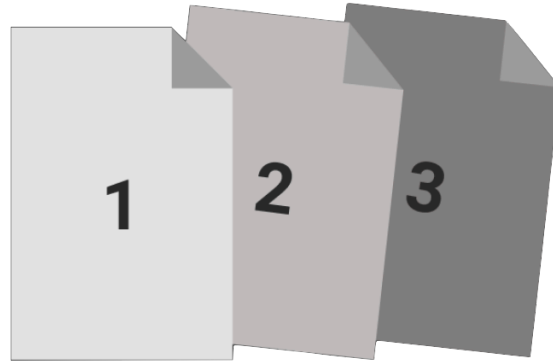

Pages and Frames

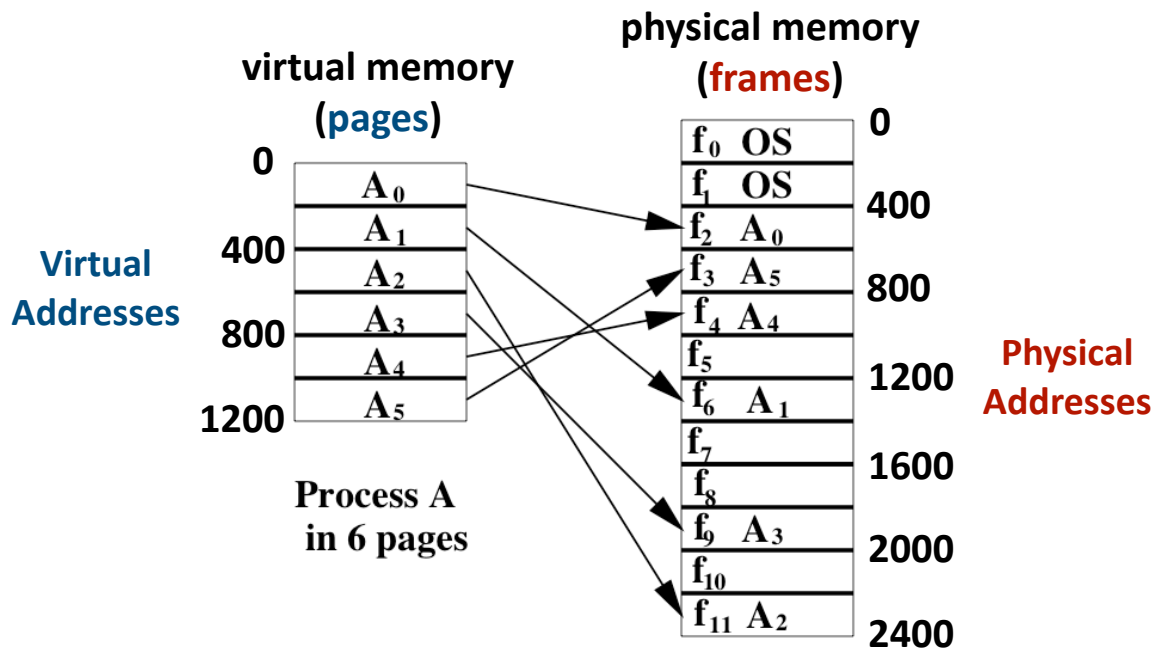

Page Tables and Address Translation

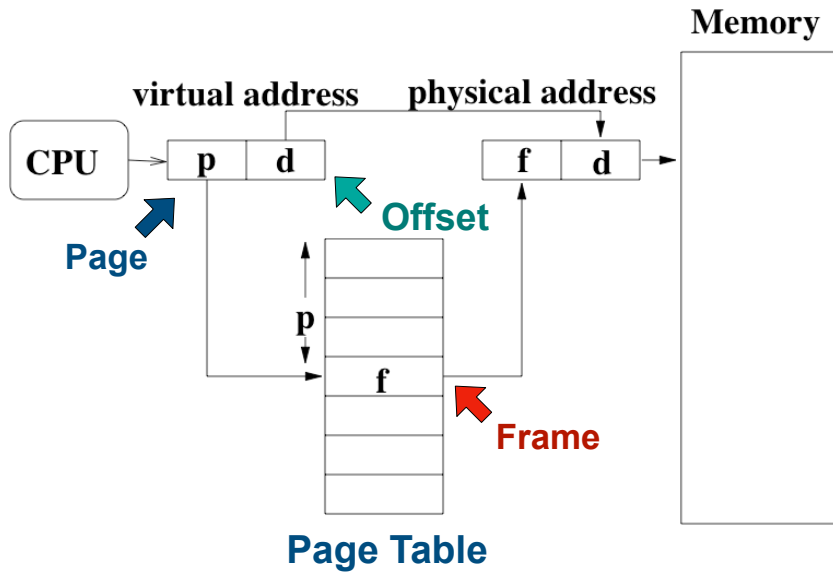

Translation Lookaside Buffer (TLB)

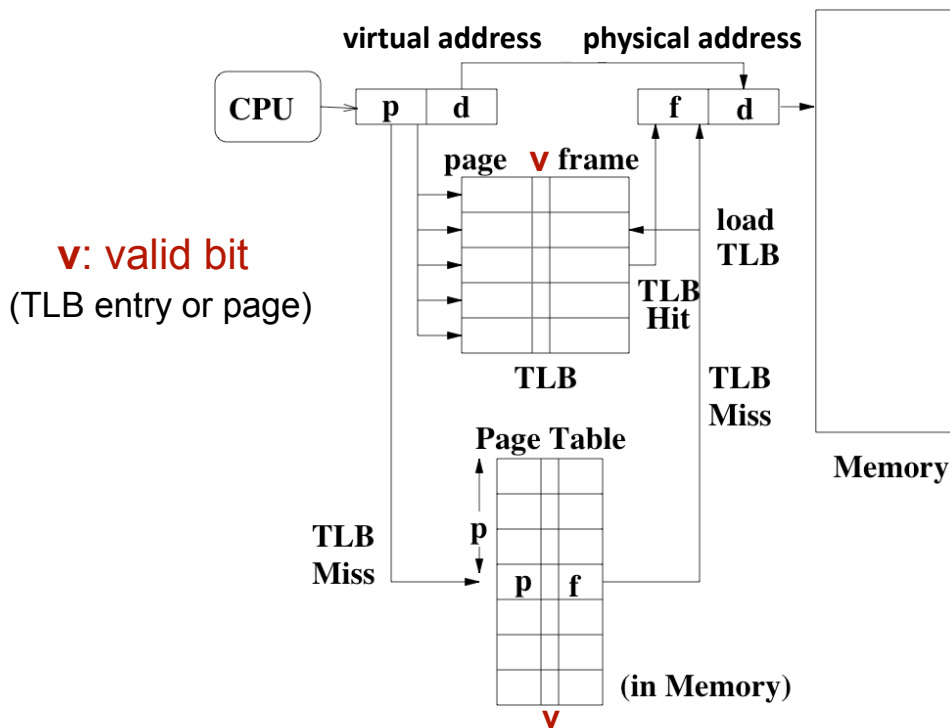

Segmented Paging

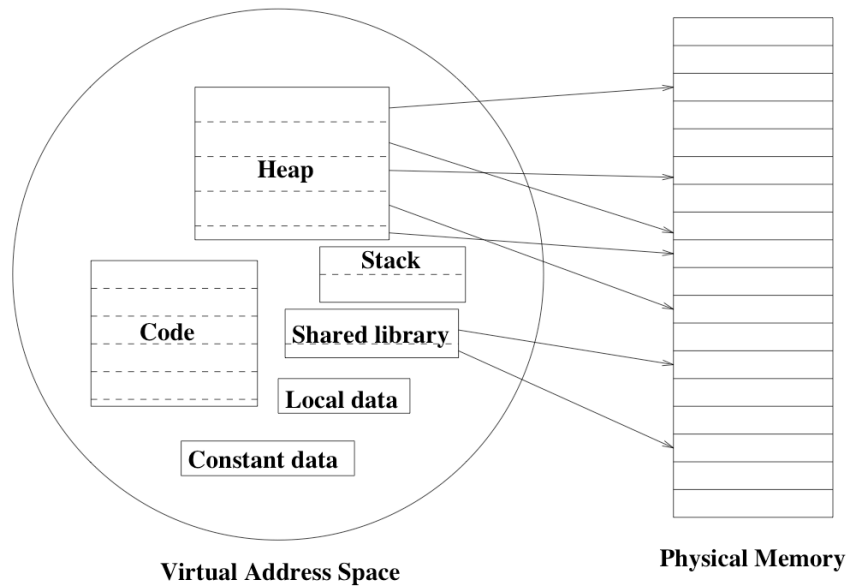

Addressing in Segmented Paging

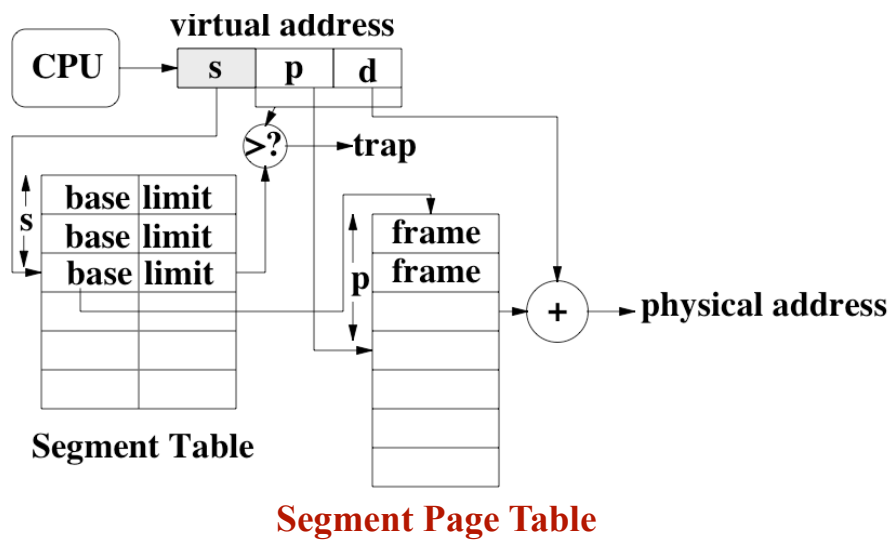

The Big Picture (so far)

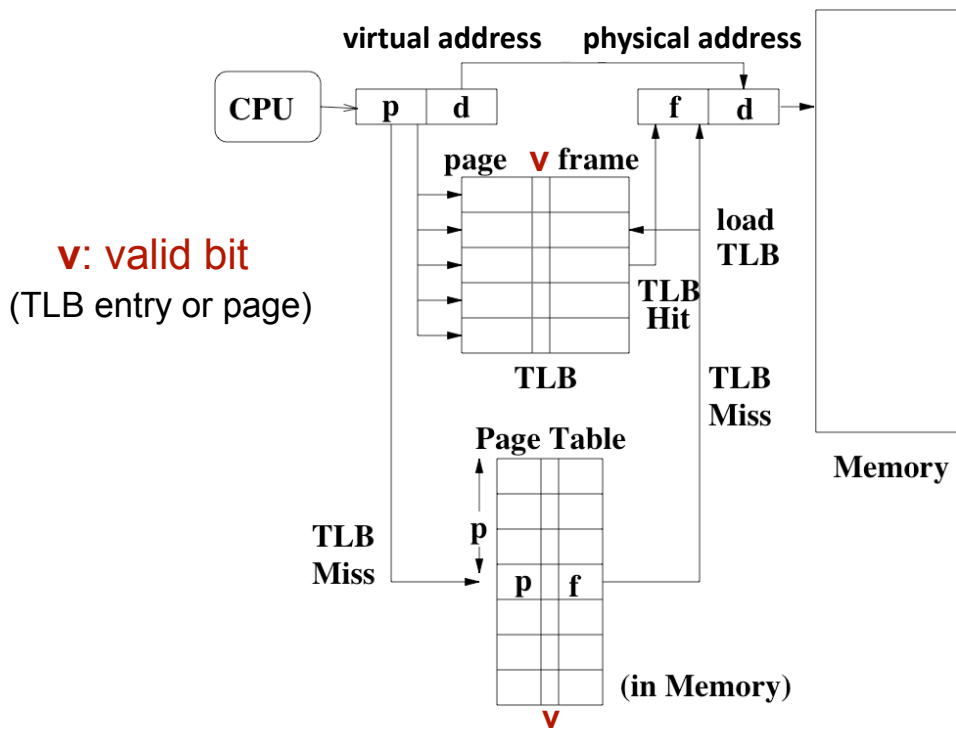

Demand Paging

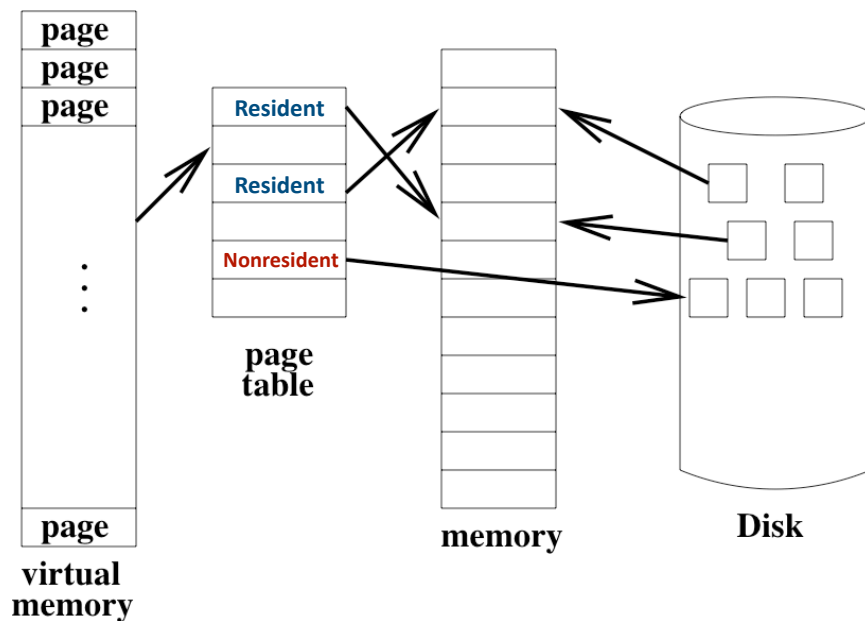

Page Replacement: FIFO, MIN, LRU

	A	B	C	A	B	D	A	D	B	C	A
frame 1	A*	A	A	A	A	D*	D	D	D	C*	C
frame 2		B*	B	B	B	B	A*	A	A	A	A
frame 3			C*	C	C	C	C	C	B*	B	B

(FIFO replacement shown)

One more example....

A B C D A B E A B C D E

(a) FIFO with 3 frames

(b) FIFO with 4 frames

Second Chance / Clock Algorithm

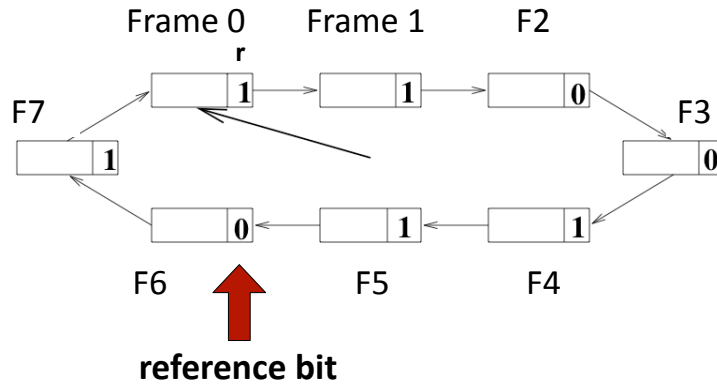

Enhanced Second Chance

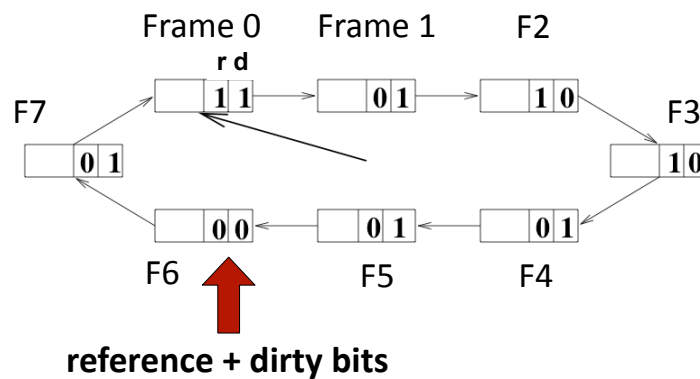

Thrashing

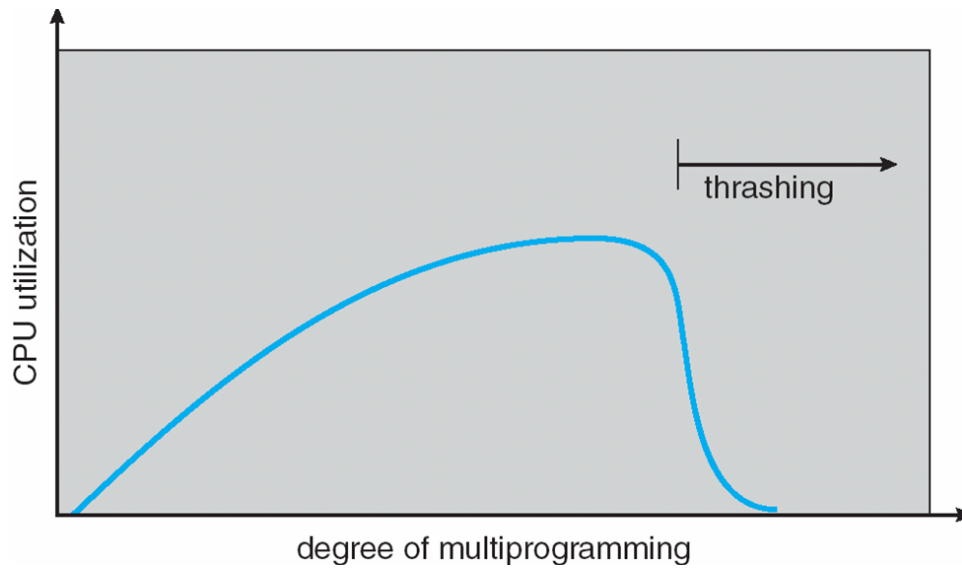

Working Set Model

page reference table

... 2 6 1 5 7 7 7 7 5 1 6 2 3 4 1 2 3 4 4 4 3 4 3 4 4 4 1 3 2 3 4 4 4 3 4 4 4 ...

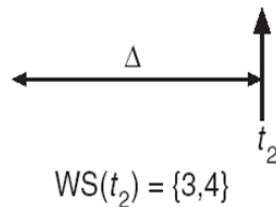
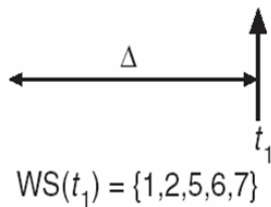

Page Fault Frequency Scheme

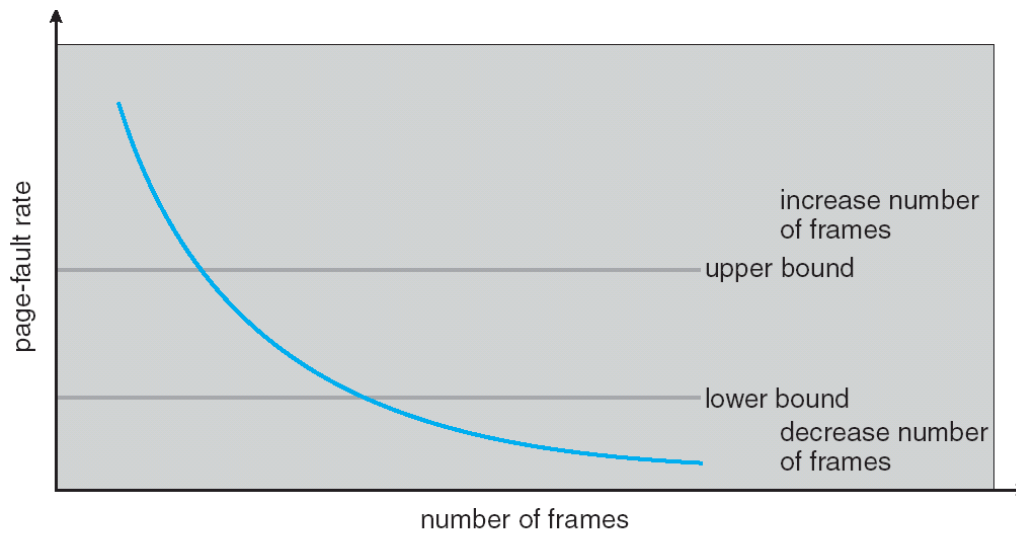

Free-Space Management

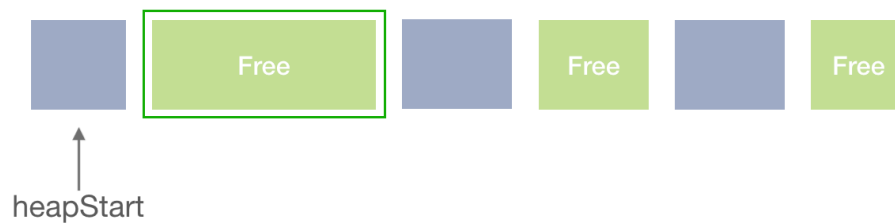

Buddy Allocation

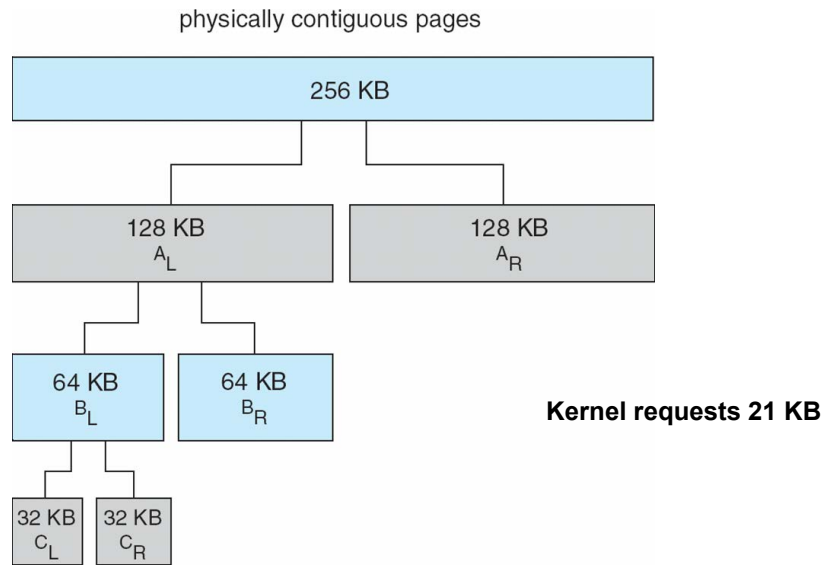

Slab Allocator (Segregated Lists)

