

# Security

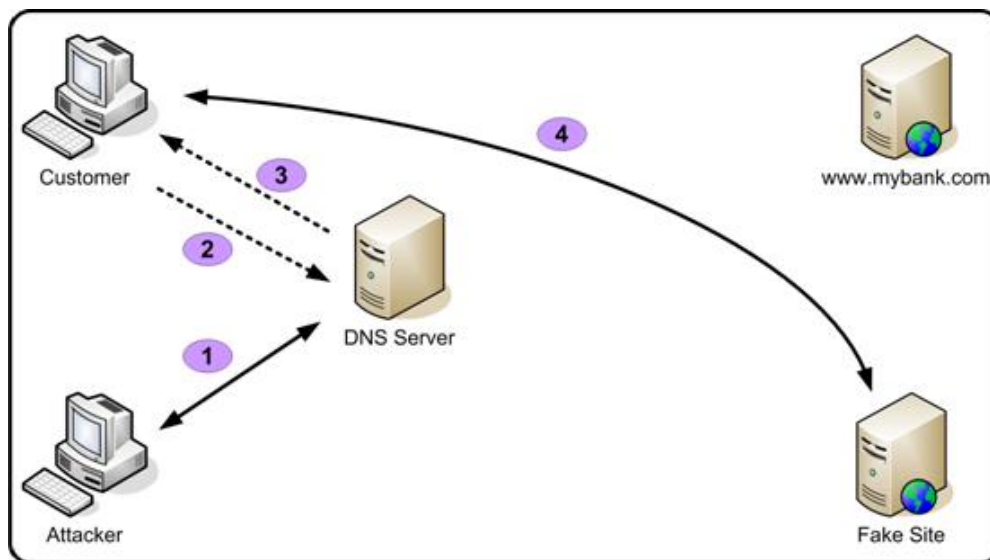

# Pharming



# Phishing

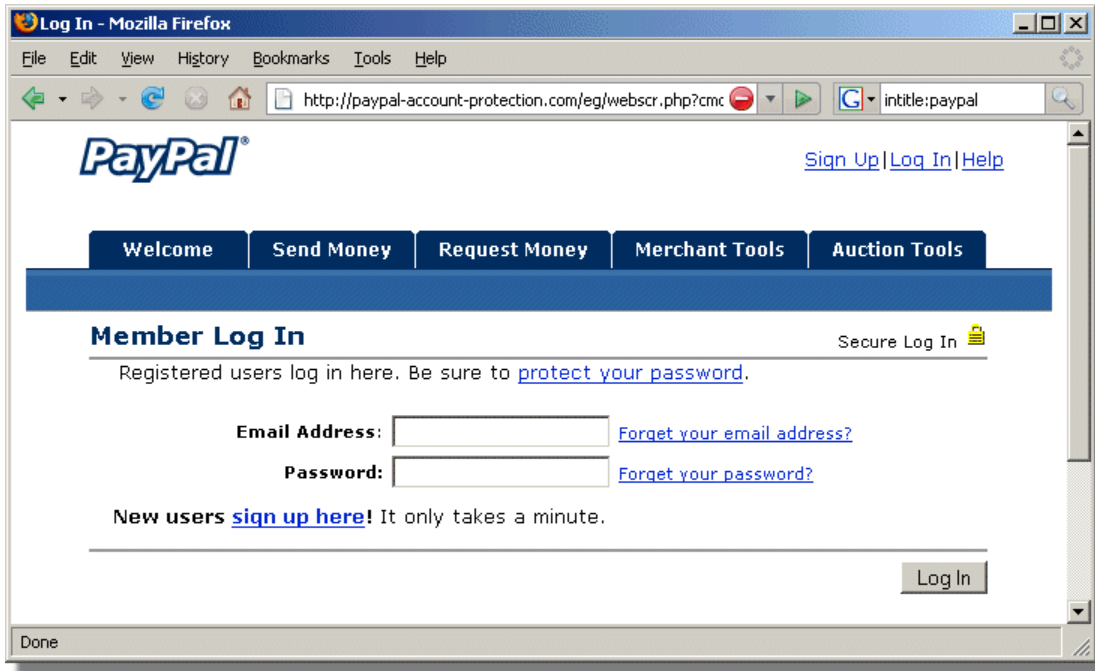

# Phishing

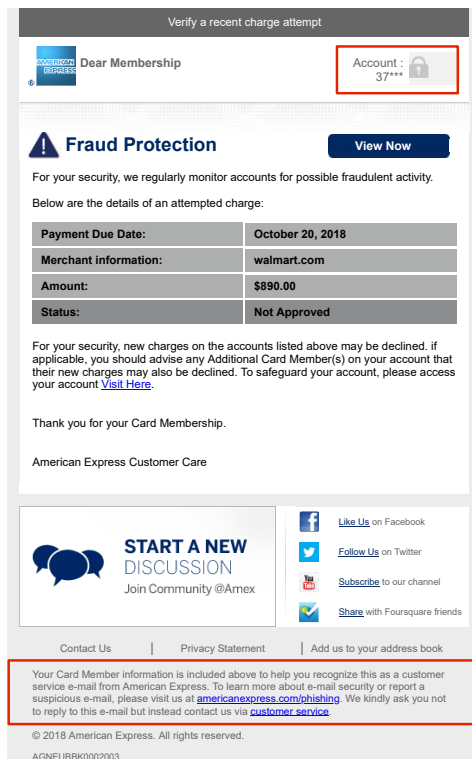
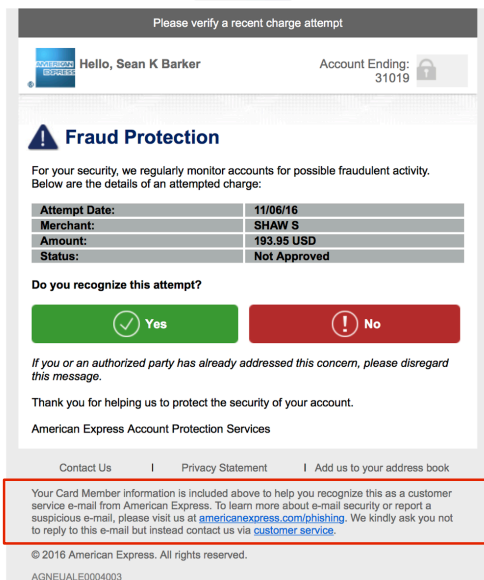

# Phishing

**From:** American Express Online 10659

**Subject:** RE: Fraud Detection: Please view your recent activity and we'll help you take corrective action. ID0225840

**Date:** October 20, 2018 at 4:50:35 PM EDT

**To:** undisclosed-recipients;

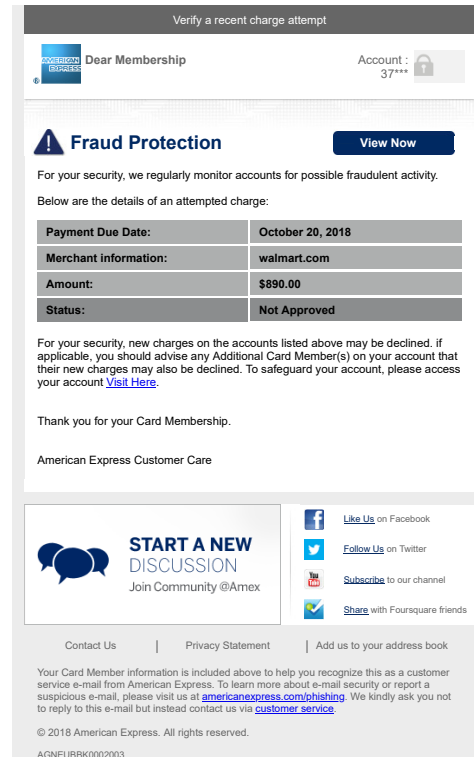

# TCP Three-Way Handshake

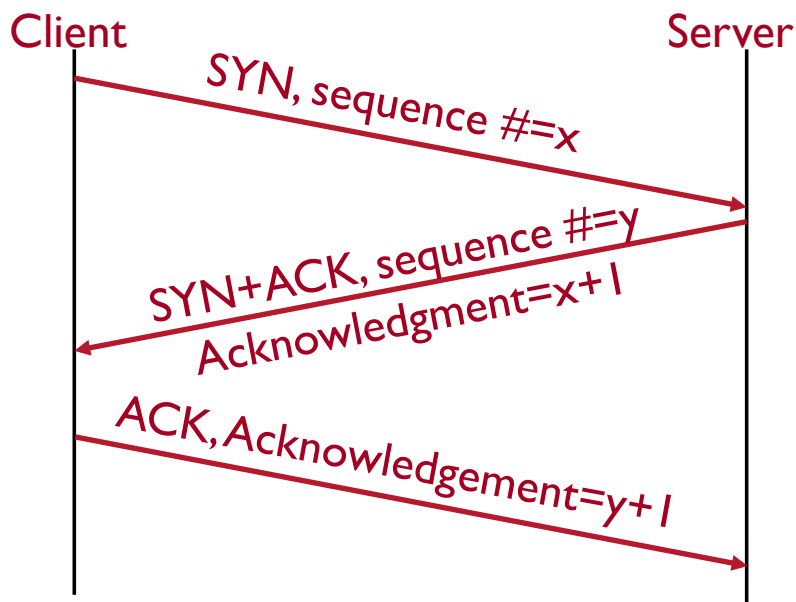

# Distributed Denial of Service (DDoS)

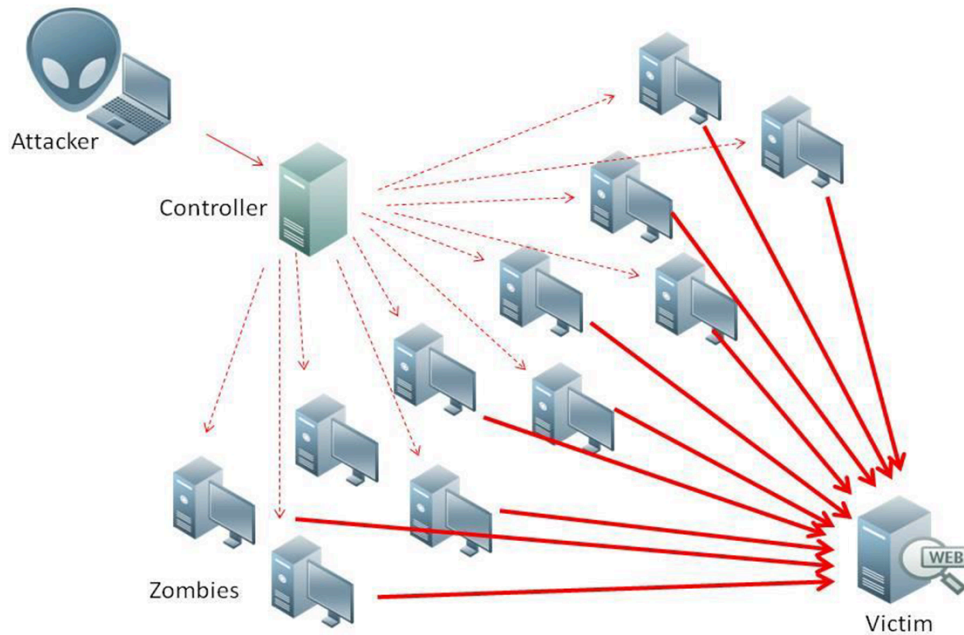

# Botnet Resource Consumption

Attack	Resource Threshold	Requests/Bot	Bots needed to exhaust
Static HTTP GET	60,000/sec	93 requests/sec at 250 bytes/request	645
Dynamic HTTP GET	3,000/sec	93 requests/sec at 250 bytes/request	40
SSL Handshake	600/sec	10 requests/sec	60

# Heartbleed (2014)

## Heartbeat – Normal usage

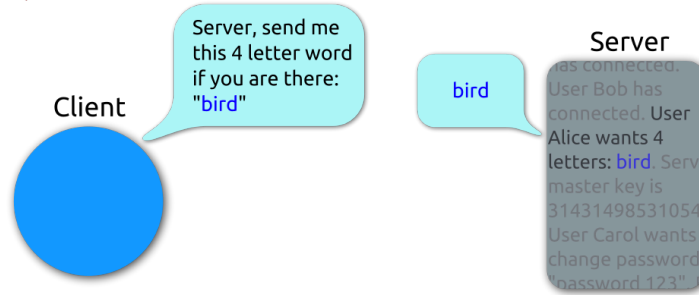

## Heartbeat – Malicious usage

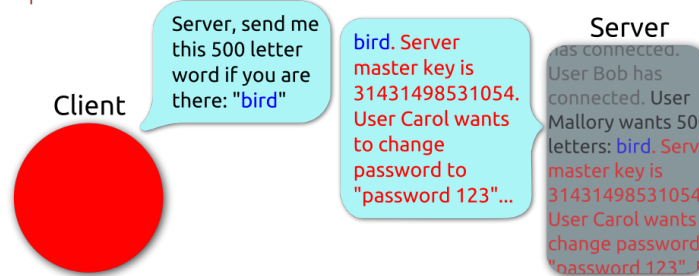

# Secure Communication



# Eavesdropping

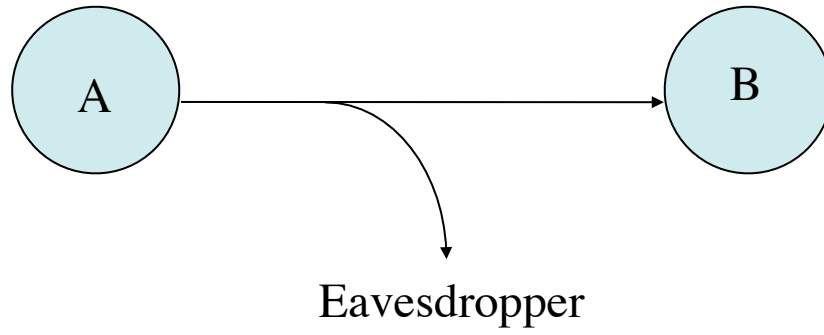

# Fabrication

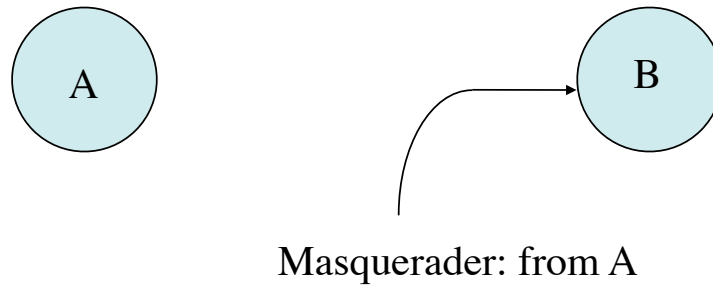

# Tampering

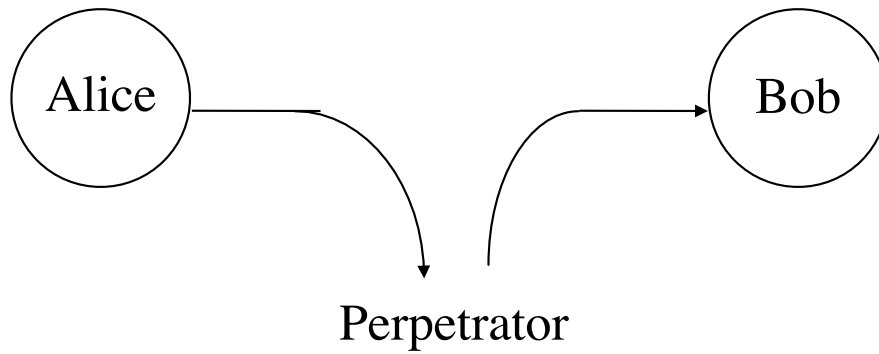

# Encryption

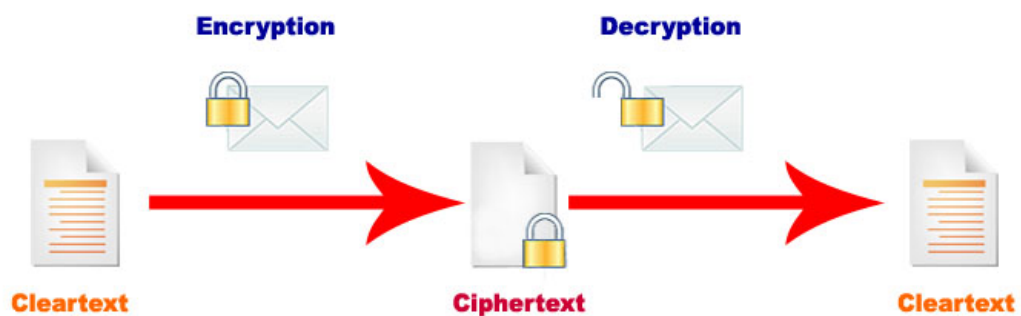

# Public Key Cryptography

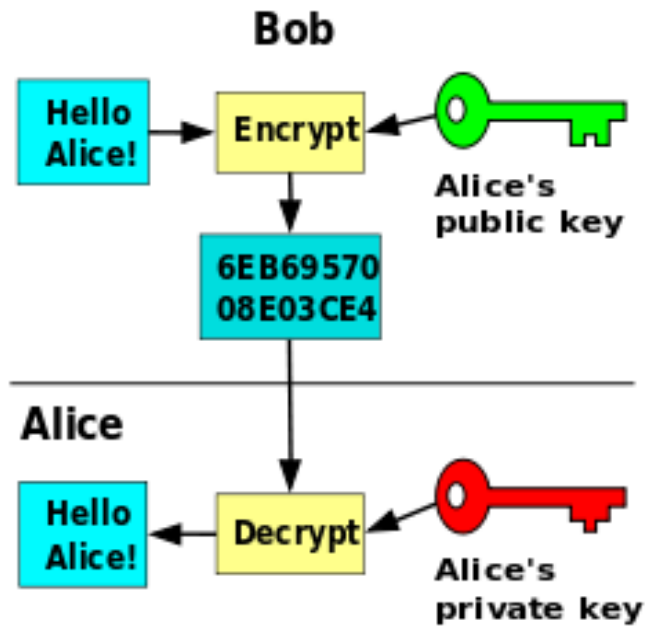

# Man in the Middle (MITM)

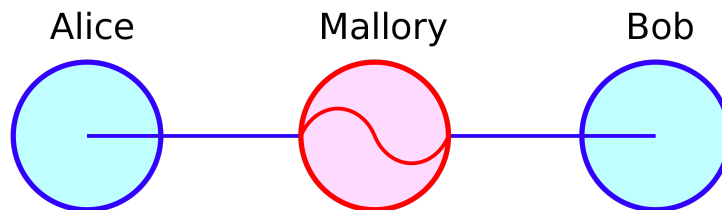



# Certification Authorities

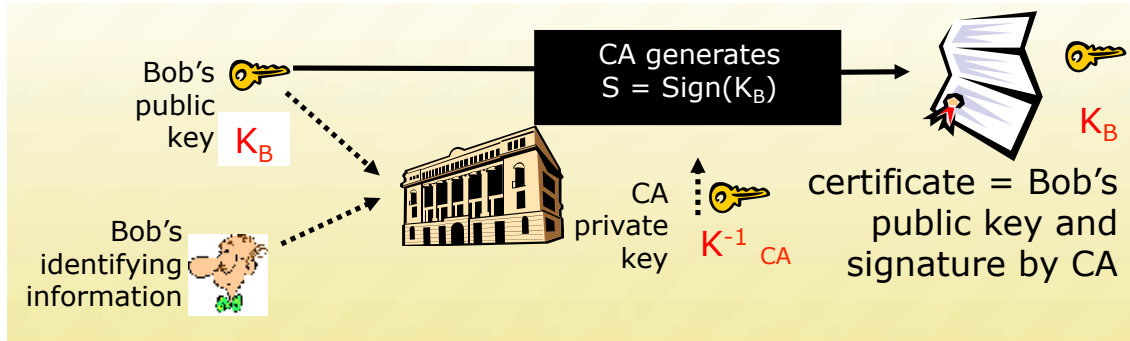

# Certificates

