

Replication & Fault Tolerance

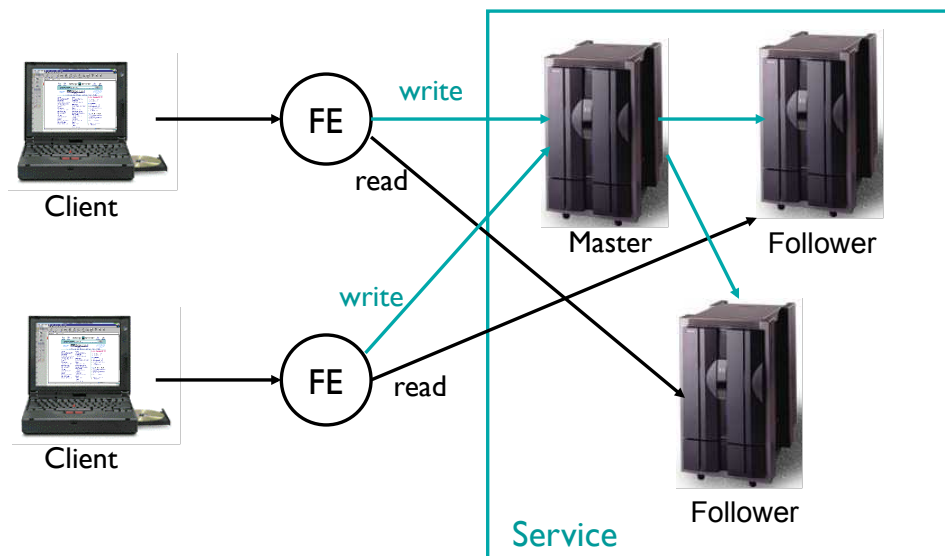

Passive Replication



Active Replication

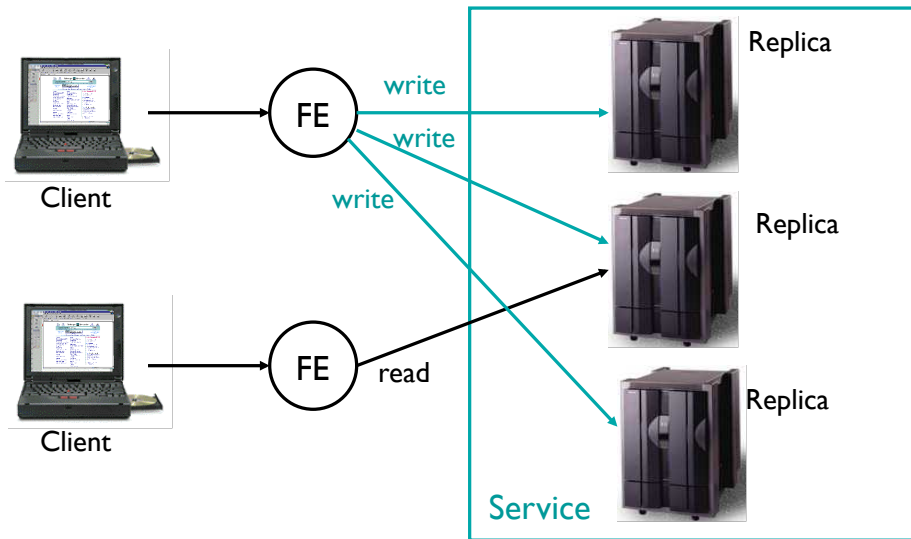

Gossip Architecture

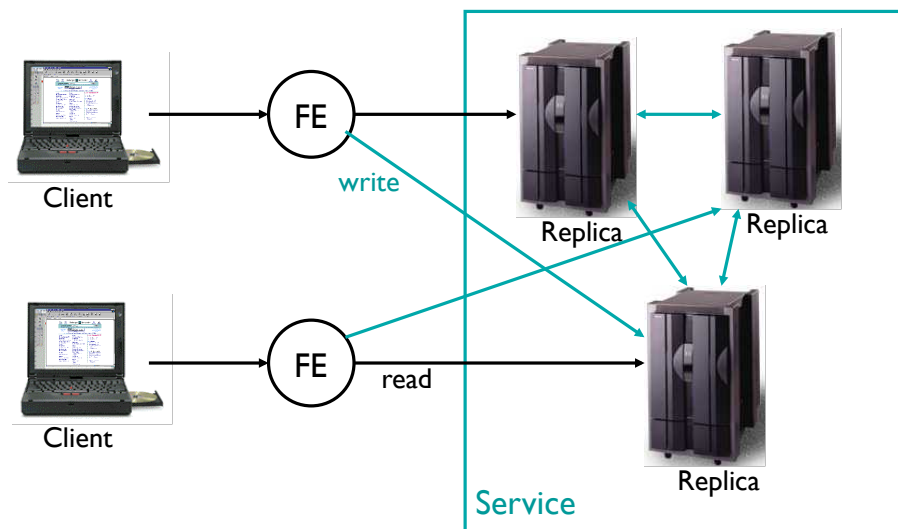

Network Partitions

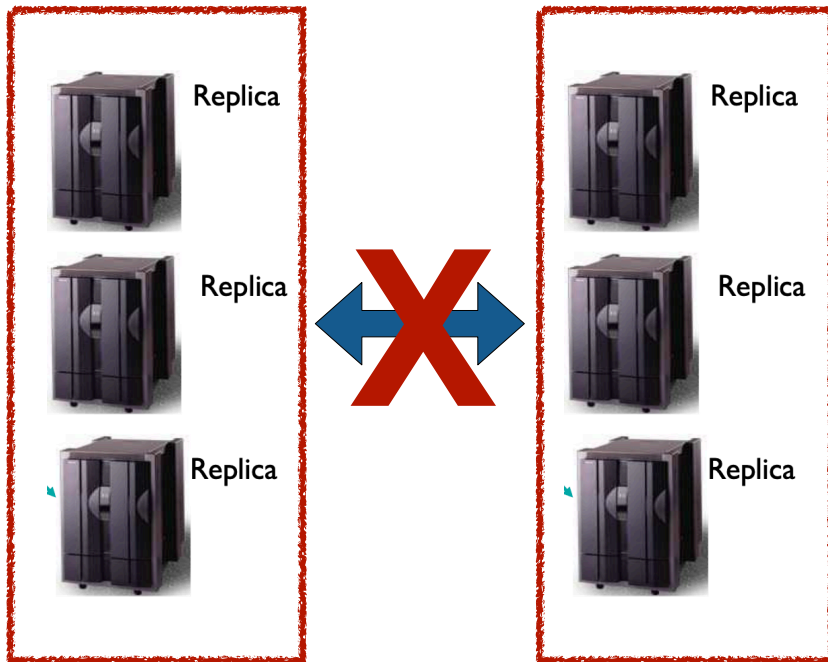

Fault Tolerance

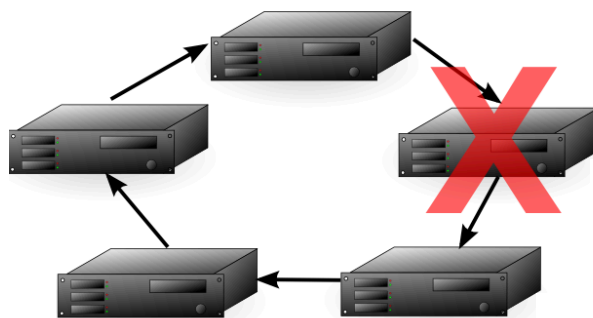

“A distributed system is one in which the failure of a computer you didn't even know existed can render your own computer unusable.”

– Leslie Lamport

Redundancy



Three Byzantine Generals

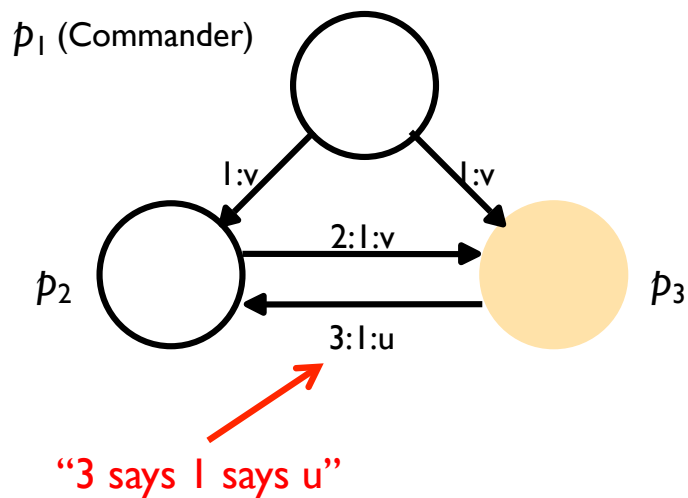

Faulty Commander

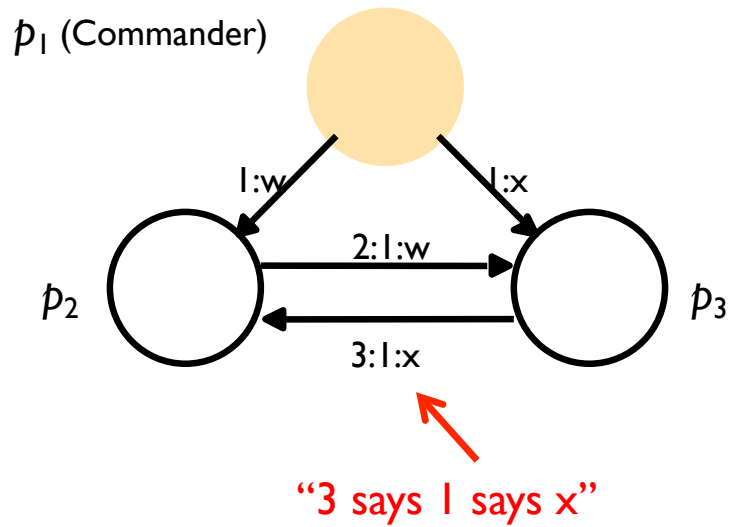

Four Generals

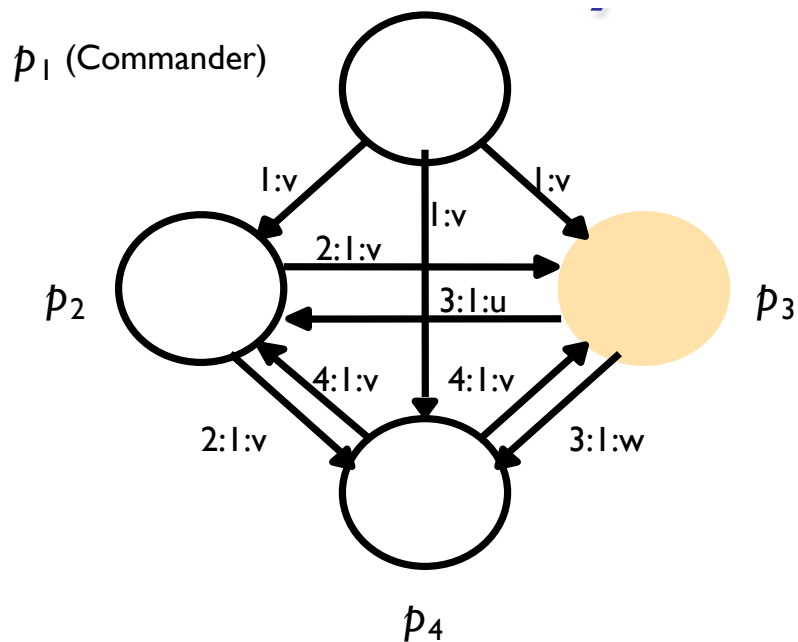

Faulty Commander (four generals)

